

ELEMENT™ 2" LED REMODEL

ADJUSTABLE DOWNLIGHT & WALL WASH

The ELEMENT 2" Remodel Adjustable Downlight delivers high performance through a 1.4" aperture from a 2.5" trim (flangeless size). Features full adjustability with lockable 0-45° tilt, 361° rotation and ELEMENT's patented high/low lamp positioning. Options include flanged or flangeless (includes mud plate), round or square and flat or beveled die-cast trims in four finishes with wet-listed options. Interchangeable optics include 20°, 30°, 40°, 60° and dedicated wall wash options. New construction option also available. Suitable for use in .375"-2" ceiling thickness. (Note: Tilt may be restricted in thicker ceilings.)

- Hot aiming/locking mechanism offers 0-45° tilt, 361° rotation, high/low lamp positioning
- Round or square, flat or beveled, flanged or flangeless die-cast trims in four finishes
- Interchangeable optics: 20°, 30°, 40°, or 60°
- Wall wash trim option
- Mechanism and junction box serviced through ceiling aperture
- Lensed and shower aperture includes Solite Soft Focus lens



2" REMODEL ADJUSTABLE FLANGED

LUMEN MULTIPLIER (CRI/CCT)

CCT	80 CRI MULTIPLIER	90 CRI MULTIPLIER
2700K	0.95	0.80
3000K	1.00	0.85
3500K	1.05	0.90

Lumen output will vary by CCT and CRI. See photometric charts for output information. Data in chart reflect 3000K/80 CRI values unless noted.

SPECIFICATIONS

	STATIC WHITE				WARM DIM
	HIGH OUTPUT		LOW OUTPUT		LOW OUTPUT
DELIVERED LUMENS	1500	1250	1163	930	850
WATTS	17	17	12	12	12
EFFICACY	88	73	97	77	71
CRI	80+	90+	80+	90+	90+
CBCP	20° - 5,136 30° - 4,644 40° - 3,050 60° - 1,764				
CCT	2700K, 3000K, or 3500K				3000K - 1800K
COLOR CONSISTENCY	1-step				2-step
VOLTAGE	120V or 277V				
DIMMING ¹	Standard reverse-phase, forward-phase, TRIAC, and 0-10V dimming down to 1%				
POWER SUPPLY	Constant Current driver with +.9 power factor and +80% efficiency				
OPTICS	20°, 30°, 40°, or 60°				
ADJUSTABILITY	0-45° tilt, 361° rotation, high/low lamp positioning				
CEILING APPEARANCE	Flanged or flangeless				
CEILING THICKNESS	Flanged or flangeless: 3/8" to 2" Note: Tilt restricted in thicker ceilings. Not for use with T-grid (acoustic tile)				
CEILING APERTURE	2-3/4" ceiling cutout				
HOUSING	Non-IC				
CONSTRUCTION	Trim: Die-Cast Aluminum				
FINISH	Housing: Black powder coat Trims: Antique Bronze, Black, Satin Nickel, or White (paintable)				
GENERAL LISTINGS	ETL Listed. Damp Location. Shower version Wet Listed.				
L70	50,000 hours min				
WARRANTY ²	5 years				

Data in chart reflect 3000K/80 CRI values unless noted. Custom output/custom RAL/custom CCT available, contact Quotes Department.

Ordering grids available on page 2.

¹See visualcomfort.com for dimmer compatibility.

²Visit visualcomfort.com for specific warranty limitations and details.

ELEMENT™ 2" LED REMODEL

ADJUSTABLE DOWNLIGHT & WALL WASH

ORDERING GRIDS

HOUSING

PRODUCT	CEILING APPEARANCE	LAMP	CRI	COLOR TEMPERATURE	BEAM SPREAD ²	FUNCTION	HOUSING RATING	DRIVER	VOLTAGE
E2R ELEMENT 2" ROUND	RL REMODEL	-LH HIGH OUTPUT	8 80 CRI	27 2700K	20 20°	A ADJUSTABLE ²	N NON-IC	120V/277V	120 VOLT
E2S ELEMENT 2" SQUARE	FLANGELESS	-LO LOW OUTPUT	9 90 CRI	30 3000K	30 30°			UNIVERSAL PHASE/ 0-10V 1% (LEAVE BLANK) ³	(LEAVE BLANK)
	RF REMODEL FLANGED			35 3500K WD WARM DIM ¹	40 40° 60 60°				-277 277 VOLT
		-				A	N		

Trims are required and must be ordered separately.

For dimming details, refer to dimmer compatibility chart.

¹WD - Warm dim 90 CRI only. Only available low output.

²A - 30° beam spread and 15° tilt optimal for wall wash use.

³Universal dimming is reverse-phase, forward-phase, TRIAC, and 0-10V. 277V is only compatible with 0-10V dimming.

TRIM

PRODUCT	CEILING APPEARANCE	STYLE	APERTURE	FINISH
E2R ELEMENT 2" ROUND	L FLANGELESS	B BEVEL	-O NO LENS	Z ANTIQUE BRONZE
E2S ELEMENT 2" SQUARE	F FLANGED	F FLAT	-H SHOWER ¹	B BLACK
		W WALL WASH ¹	-L LENSED	S SATIN NICKEL
			-W WALL WASH (LENSED) ²	W WHITE
			-	

¹H - Shower lens includes a gasket.

²W - Wall wash style trim requires wall wash lensed aperture -W.

PLASTER PLATES

PRODUCT	
150E2RCL	2" PLASTER PLATE ROUND SHEET METAL
150E2SCL-A	2" PLASTER PLATE SQUARE SHEET METAL

Plaster plates are used to convert flanged housings into flangeless housings.

Ships standard with flangeless housings.

REPLACEMENT OPTICS

PRODUCT	BEAM SPREAD
353LEDGATOPT	20 20° 30 30° 40 40° 60 60°

353LEDGATOPT

LENSES/LOUVERS¹

PRODUCT	TYPE
MOC	GG PLAIN GLASS SF SOFT GLASS LL LINEAR SPREAD EC EGGCRATE LOUVER LS1 1" LONG SNOOT LS12 1/2" LONG SNOOT

MOC

¹Lenses/louvers mounted to lamp assembly only (max 2).



ELEMENT™ 2" LED REMODEL

ADJUSTABLE DOWNLIGHT & WALL WASH

TRIMS

FLANGED

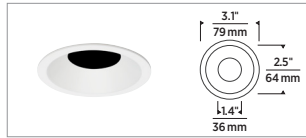

ROUND BEVEL

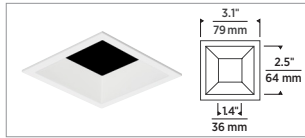

SQUARE BEVEL

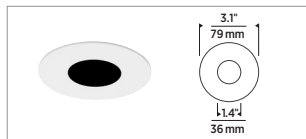

ROUND FLAT

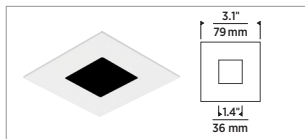

SQUARE FLAT

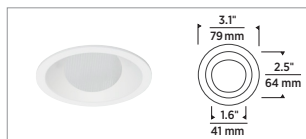

ROUND WALL WASH

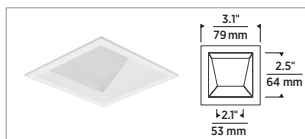

SQUARE WALL WASH

FLANGELESS

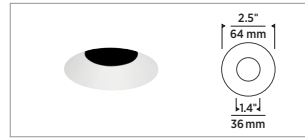

ROUND BEVEL

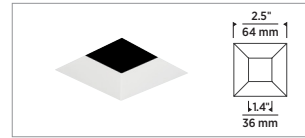

SQUARE BEVEL

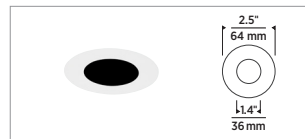

ROUND FLAT

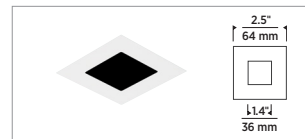

SQUARE FLAT



ROUND WALL WASH



SQUARE WALL WASH

FINISH



ANTIQUE BRONZE



BLACK



SATIN NICKEL



WHITE (PAINTABLE)

LENS OPTION



SHOWN WITH AND WITHOUT A LENS
(ROUND FLANGELESS BEVEL)



SHOWN WITH AND WITHOUT A LENS
(SQUARE FLANGED BEVEL)

ELEMENT™ 2" LED REMODEL

ADJUSTABLE DOWNLIGHT & WALL WASH

WARM DIM CURVE

CCT vs. Forward Current, $T_c=25^\circ\text{C}$

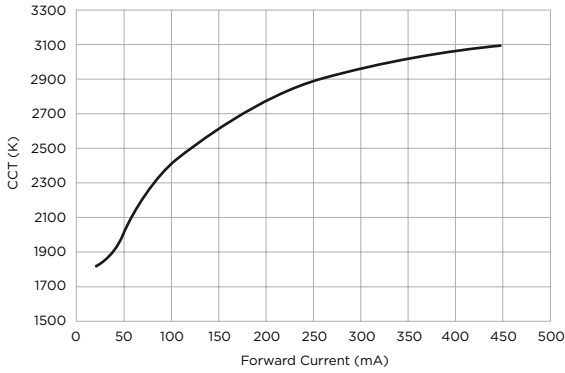

2" MECHANISM

ROUND

5.25" MIN PLENUM HEIGHT

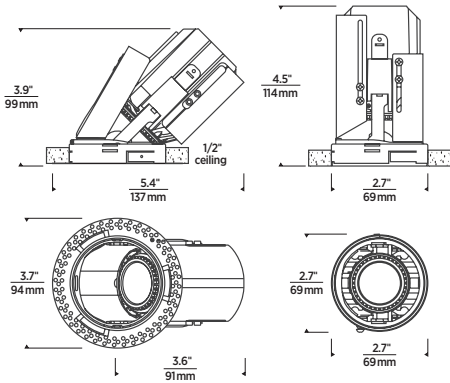

Shown in round flangeless at full tilt (40°)

Shown in round flanged at no tilt (0°)

SQUARE

5.25" MIN PLENUM HEIGHT

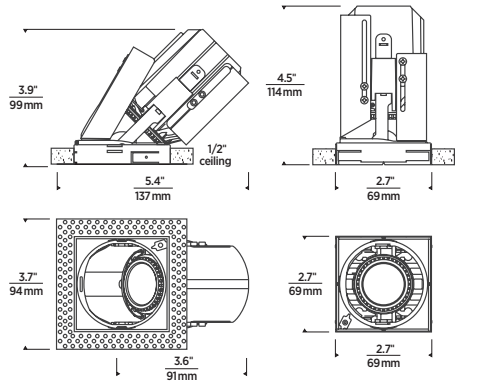

Shown in square flangeless at full tilt (40°)

Shown in square flanged at no tilt (0°)

REMOTE DRIVER J-BOX

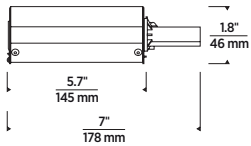

ELEMENT™ 2" LED REMODEL

ADJUSTABLE DOWNLIGHT & WALL WASH

ELEMENT Specular Reflectors reduce glare while creating a clean, quiet ceiling appearance. These beautiful trim accessories have been specifically designed to minimize any effect on light performance, color and output. Specular Reflectors are available for both Adjustable and Fixed downlights and are compatible with ELEMENT 2" trims and housings.

- Can be easily installed or removed
- Assembles to existing ELEMENT 2" trim
- Compatible with fixed and adjustable housings

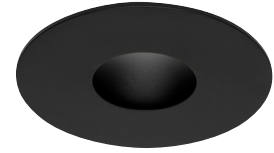



















BELOW CEILING VIEW



SHOWN MOUNTED TO TRIM



REFLECTOR ONLY

COMPATIBLE TRIMS	NON-SLOTTED FOR FIXED ¹	SLOTTED FOR ADJUSTABLE
 2" round, flanged, bevel	 E2TREFNS3B	 E2TREFS4B
 2" round, flanged, flat	 E2TREFNS2B	 E2TREFS3B
 2" round, flangeless, bevel	 E2TREFNS3B	 E2TREFS4B
 2" round, flangeless, flat	 E2TREFNS2B	 E2TREFS3B
 2" square, flangeless, bevel	 E2TREFNS1B	 E2TREFS2B
 2" square, flanged, bevel	 E2TREFNS1B²	 E2TREFS2B²

Only compatible with ELEMENT 2" LED series.

May require lamp to be placed in high position.

Not available for ELEMENT 2" square flat trims.

Not compatible with lensed trims.

¹Non-slotted reflectors may be used in adjustable housings with the lamp assembly placed in the 0° tilt position.

²Not compatible with flanged trim extenders F6, F7, F8, F1.

ORDERING GRIDS

E2 TRIM MOUNTED REFLECTORS¹

PRODUCT	STYLE	FINISH
E2TREF	NS1 NON-SLOTTED	B ANODIZED BLACK
	NS2 NON-SLOTTED	
	NS3 NON-SLOTTED	
	S2 SLOTTED	
	S3 SLOTTED	
	S4 SLOTTED	

E2TREF **B**

¹Not compatible with lensed trims. Reflectors are placed on top of the inside of the trim or affixed via screws (only if provided).

ELEMENT™ 2" LED REMODEL

ADJUSTABLE DOWNLIGHT & WALL WASH

PHOTOMETRICS

Description: 2" LED Module
20° Beam - 0° Tilt, 3000K

Model: E2 Adjustable
20° High Output

Input Power (Watts): 18.7
Input Power Factor: 0.98

Absolute Luminous Flux (Lumens): 1206
Lumen Efficacy (Lumens per Watt): 64.5

Description: 2" LED Module
30° Beam - 0° Tilt, 3000K

Model: E2 Adjustable
30° High Output

Input Power (Watts): 18.7
Input Power Factor: 0.98

Absolute Luminous Flux (Lumens): 1414
Lumen Efficacy (Lumens per Watt): 75.5

Description: 2" LED Module
40° Beam - 0° Tilt, 3000K

Model: E2 Adjustable
40° High Output

Input Power (Watts): 18.7
Input Power Factor: 0.98

Absolute Luminous Flux (Lumens): 1565
Lumen Efficacy (Lumens per Watt): 83.7

Output difference between CCTs - 5%, CRIs - 15%.

ANGLE	0°	45°	90°
0°	5136	5136	5136
5°	4054	4347	4616
10°	2654	2956	3278
15°	1383	1756	1896
20°	627	878	924
25°	249	326	393
30°	81	128	151
35°	24	65	50
40°	6	30	12
45°	3	6	4
50°	1	2	2
55°	1	1	1
60°	0	1	0
65°	0	1	0
70°	0	1	0
75°	0	1	0
80°	0	0	0
85°	0	0	0
90°	0	0	0

ANGLE	0°	45°	90°
0°	4644	4644	4644
5°	4184	4322	4434
10°	3249	3454	3698
15°	1948	2286	2488
20°	933	1178	1304
25°	342	428	544
30°	87	161	176
35°	27	68	52
40°	7	27	12
45°	2	5	4
50°	1	2	1
55°	0	1	0
60°	0	1	0
65°	0	1	0
70°	0	0	0
75°	0	0	0
80°	0	0	0
85°	0	0	0
90°	0	0	0

ANGLE	0°	45°	90°
0°	3050	3050	3050
5°	2774	2892	2971
10°	2436	2549	2701
15°	1847	2085	2260
20°	1188	1460	1594
25°	571	776	959
30°	216	353	411
35°	84	142	154
40°	30	53	55
45°	11	18	20
50°	1	7	4
55°	0	2	0
60°	0	0	0
65°	0	0	0
70°	0	0	0
75°	0	0	0
80°	0	0	0
85°	0	0	0
90°	0	0	0

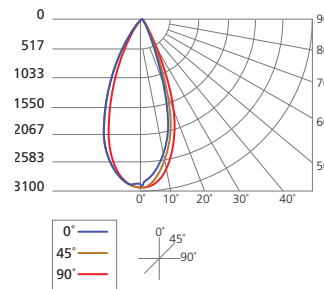
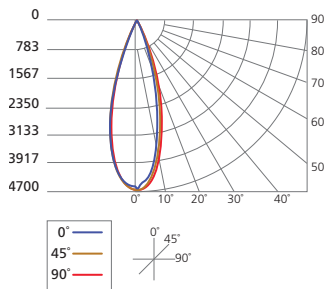
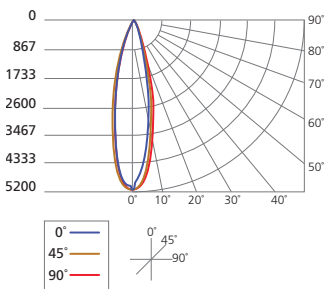
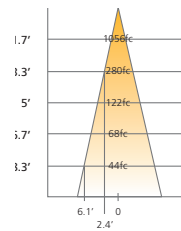
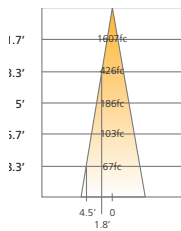
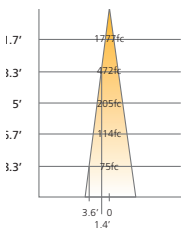

ELEMENT™ 2" LED REMODEL

ADJUSTABLE DOWNLIGHT & WALL WASH

PHOTOMETRICS

Description: 2" LED Module
 60° Beam - 0° Tilt, 3000K

Model: E2 Adjustable
 60° High Output

Input Power (Watts): 18.7
 Input Power Factor: 0.98

Absolute Luminous Flux (Lumens): 1382

Lumen Efficacy (Lumens per Watt): 73.7

Output difference between CCTs - 5%, CRIs - 15%.

ANGLE	0°	45°	90°
0°	1764	1764	1764
5°	1667	1724	1721
10°	1562	1612	1629
15°	1380	1445	1483
20°	1109	1233	1235
25°	718	921	923
30°	442	638	542
35°	310	377	350
40°	208	239	238
45°	83	142	139
50°	1	70	26
55°	1	6	1
60°	0	1	0
65°	0	0	0
70°	0	1	0
75°	0	0	0
80°	0	0	0
85°	0	0	0
90°	0	0	0

