

# Round or Square Element 4" Pro Series Housing

E4P\_D\_ 1.2



ELEMENT

## GENERAL PRODUCT INFORMATION:

This product is suitable for indoor locations.

This product can be dimmed with a standard electronic dimmer.

This instruction shows a typical installation.



## CAUTION - RISK OF FIRE

This product must be installed in accordance with the applicable installation code by a person familiar with the construction and operation of the product and the hazards involved.

**Use minimum 90°C supply conductors.**

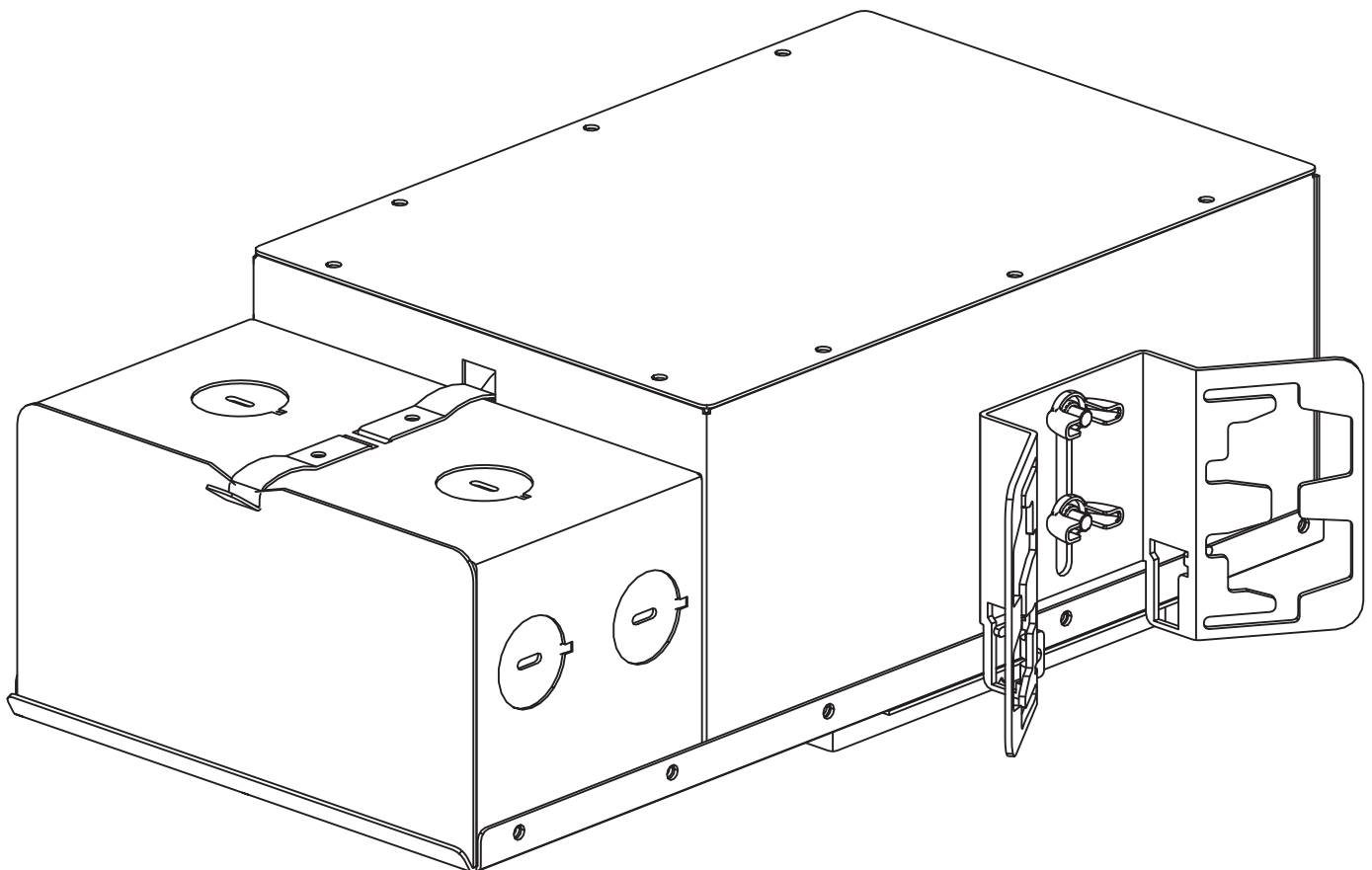

7400 Linder Ave., Skokie, IL 60077  
T 847.410.4400 | F 847.410.4500  
[www.techlighting.com](http://www.techlighting.com)

## Install the Housing with Butterfly Brackets

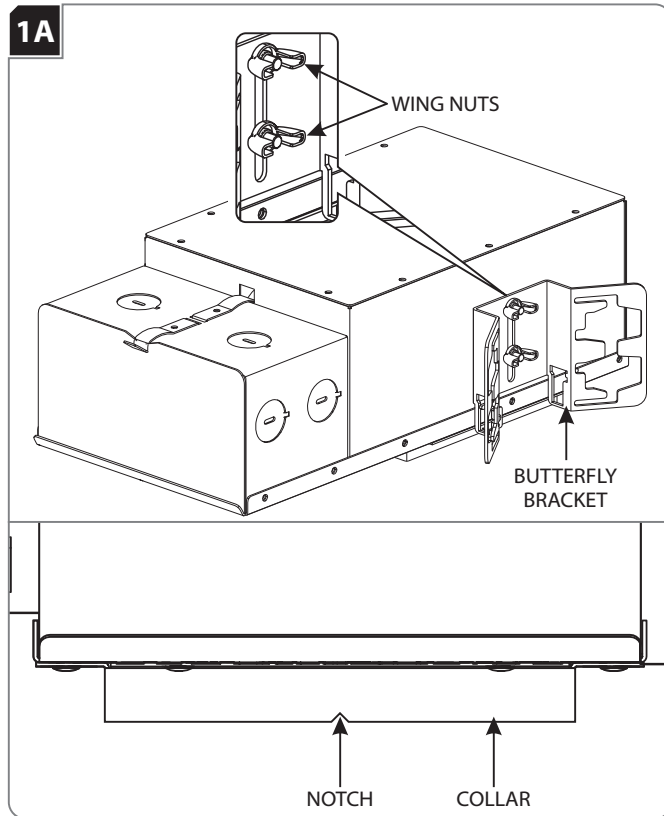

- 1 Slightly loosen the wing nuts located on the side of the housing to slide the butterfly bracket up or down.
- 2 After achieving the proper location, tighten the wing nuts to secure the butterfly bracket in place.
- 3 Repeat steps 1 and 2 on for the other butterfly bracket.
- 4 Utilize the butterfly brackets to install the housing in accordance with local electrical codes.

**NOTE:** Notches in the collar can be used to align multiple housings using a laser or string.

## Connect Power to the Housing

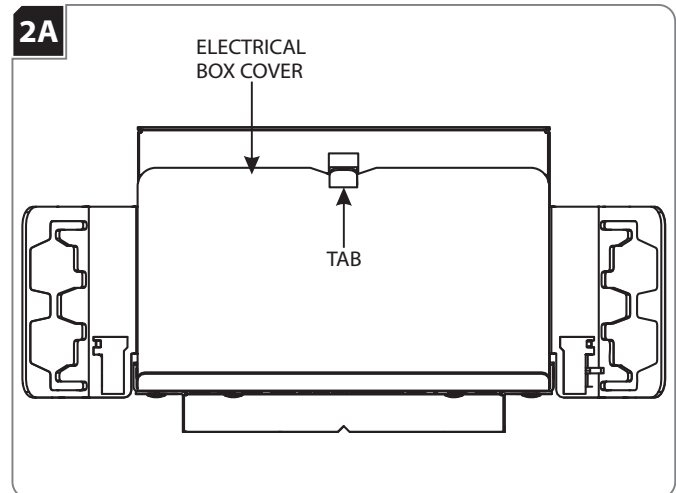

- 1 Push the tab on the housing electrical box up and remove the electrical box cover.

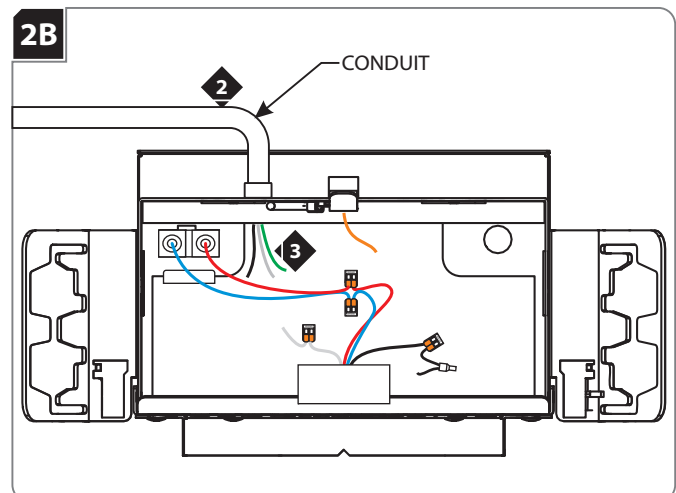

- 2 Install the conduit to the housing electrical box.
- 3 Run the power line wires into the housing electrical box.
- 4 Use the appropriate wiring diagram on the following page to wire your fixture accordingly.

**NOTE:** When a fixture is installed in a location that requires servicing from below the ceiling through the fixture aperture, the branch circuit connections need to be able to be brought out through the aperture. To accomplish this, an NM type cable in conjunction with snap-in/push-in connectors must be used and a 12" service loop must be left available outside of the fixture housing wiring compartment to allow additional branch circuit wiring to be pulled through the snap-in/push-in connector and extended out through the aperture below ceiling level.

**WARNING: RISK OF FIRE:** When using the housing electrical box for power feed through, use **MAX** 4 - #12 AWG, or 6 - #14 AWG branch circuit wires.

# IC LABELED FIXTURE WIRING

## Standard Driver Wiring

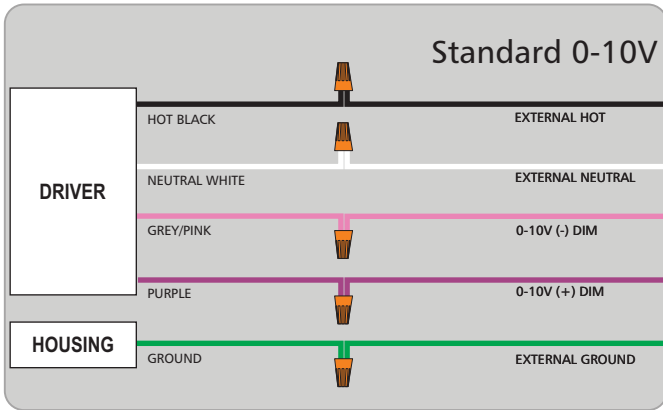
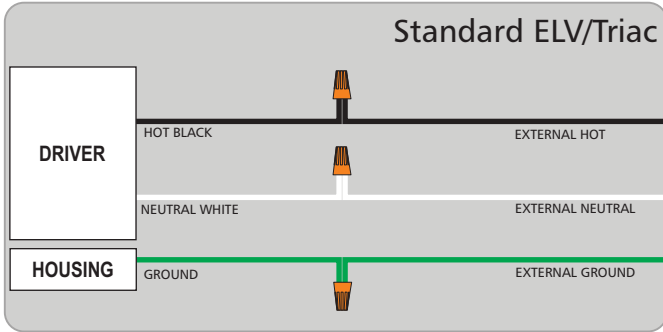

## Hi-Lume Driver Wiring

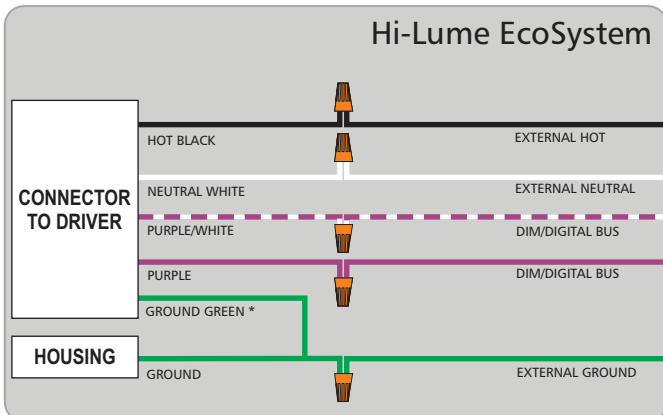
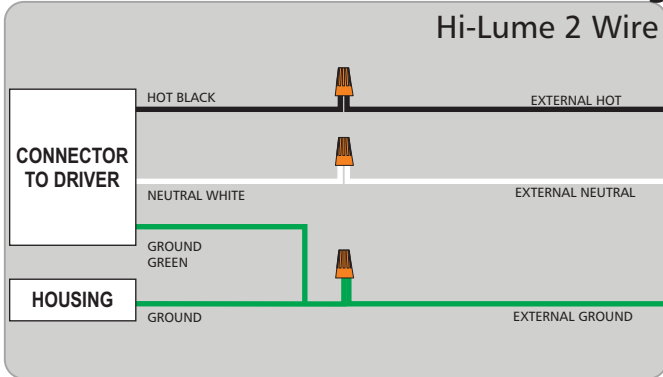

\* If green/ground connection is available, wire to ground.

## EldoLED Driver Wiring

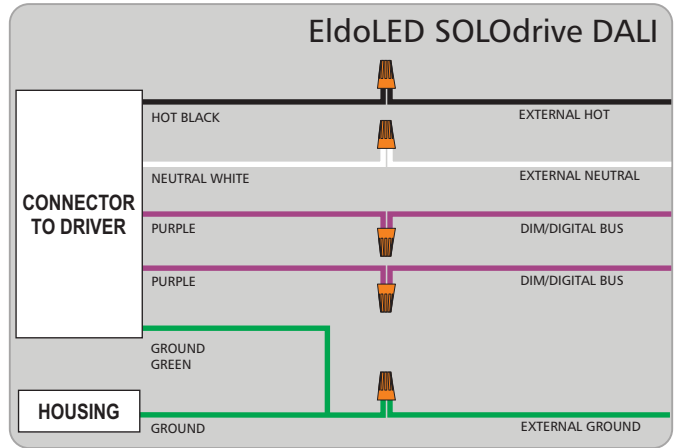
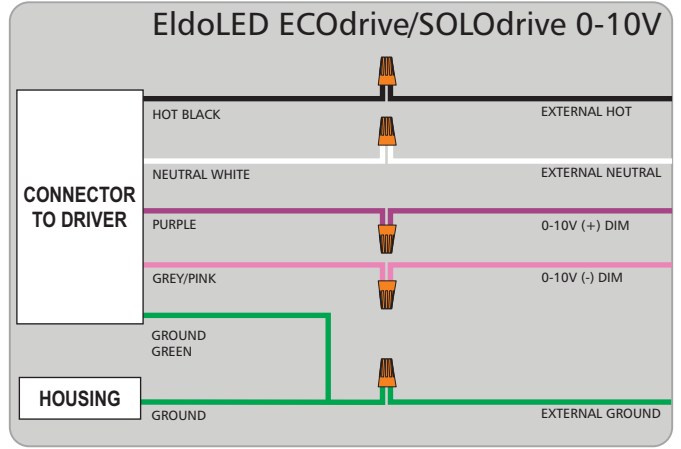

## EldoLED Tunable White Wiring

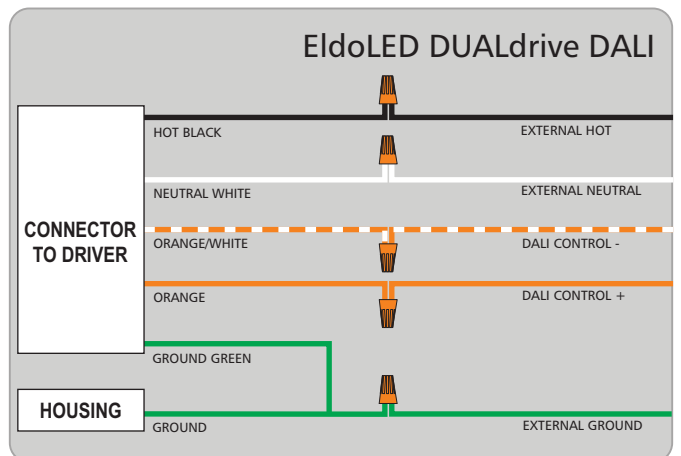
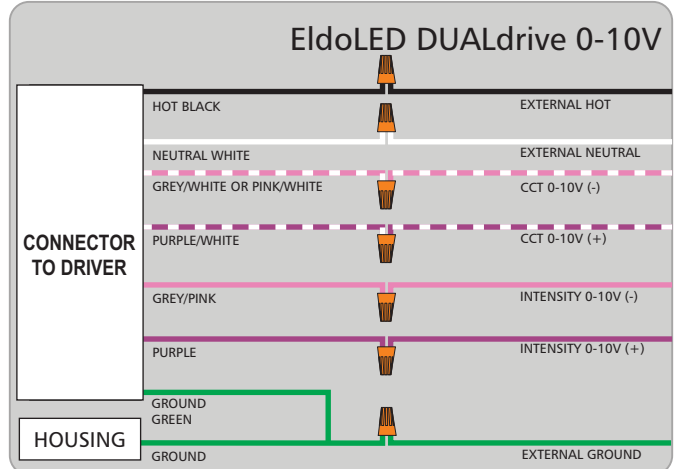

# NON-IC LABELED FIXTURE WIRING

## Standard Driver Wiring

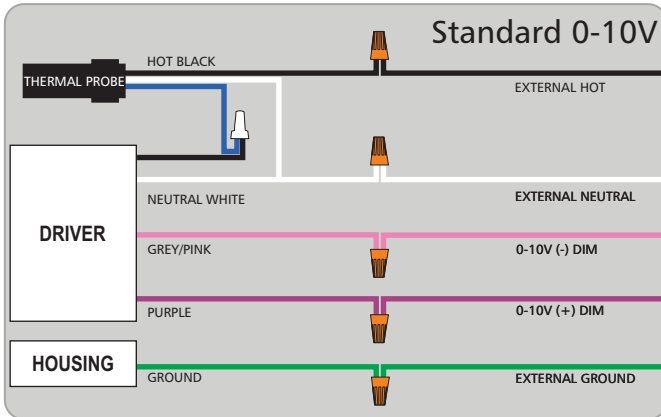
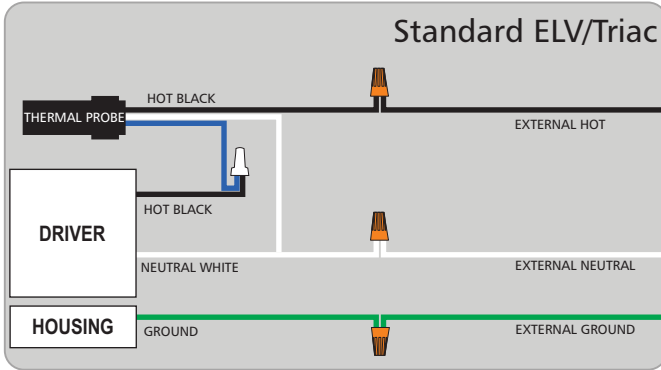

## Hi-Lume Driver Wiring

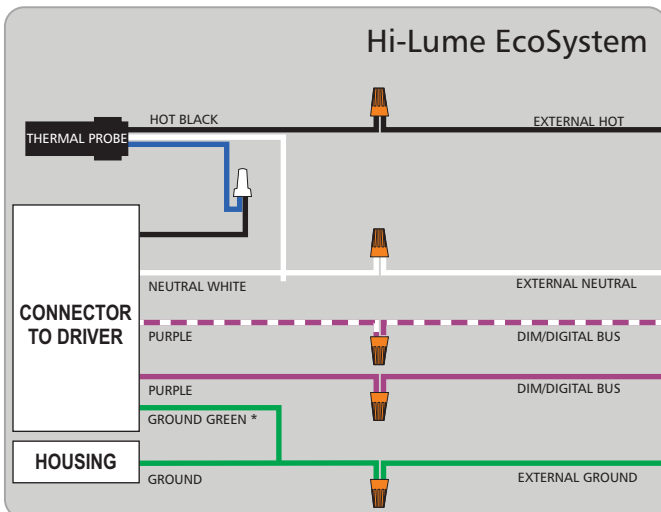
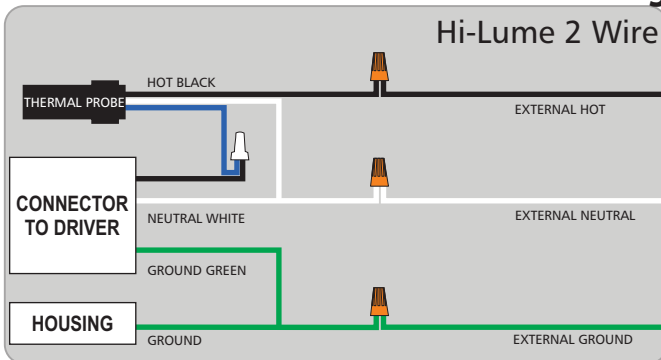

## EldoLED Driver Wiring

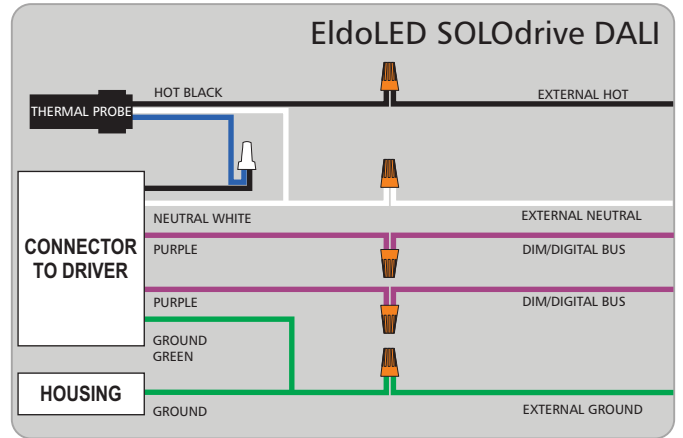
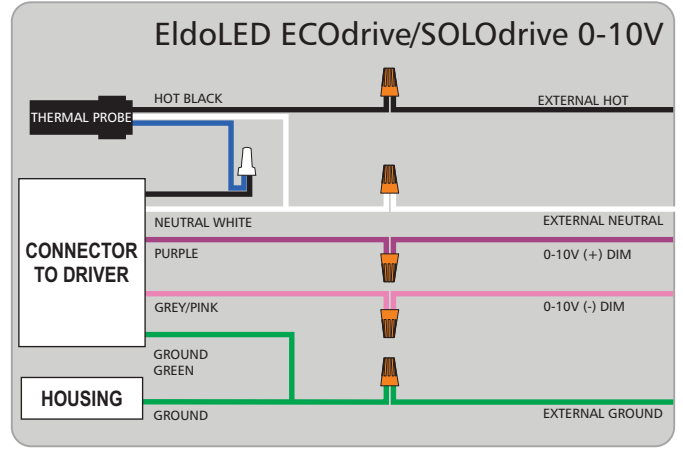

## EldoLED Tunable White Wiring

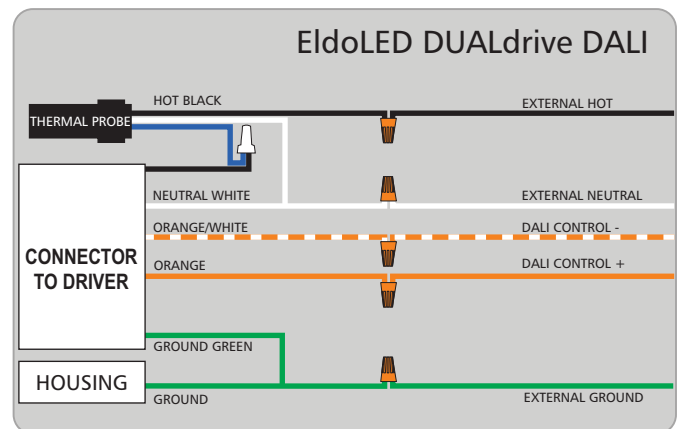
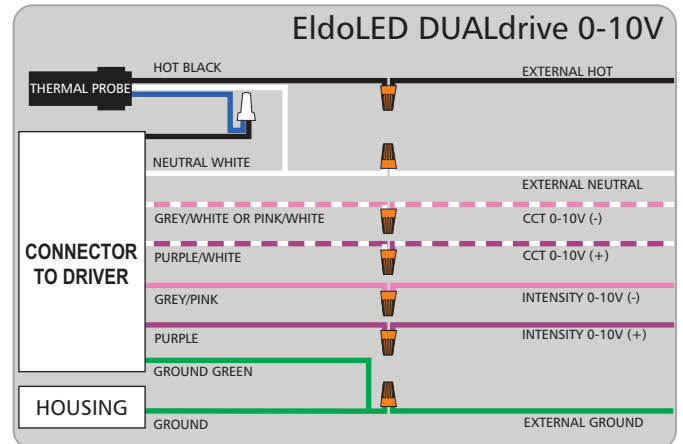

\* If green/ground connection is available, wire to ground.

## Install Drywall

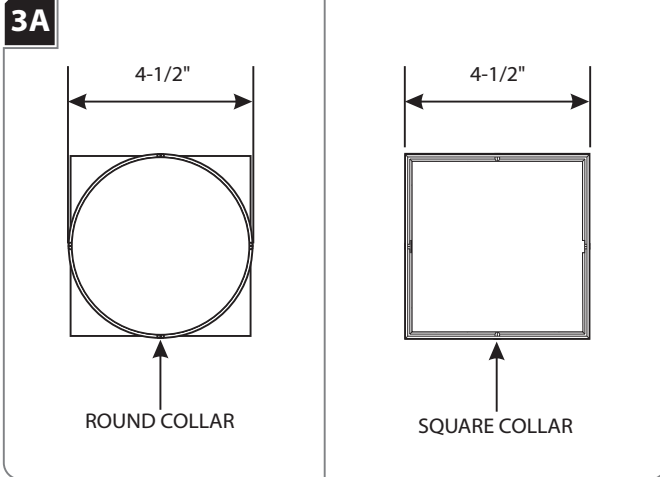

- 1** For round trims, mark a 4-1/2" diameter circle on drywall. Cut out the marked section. For square trims, mark a 4-1/2" square on drywall. Cut out the marked section.

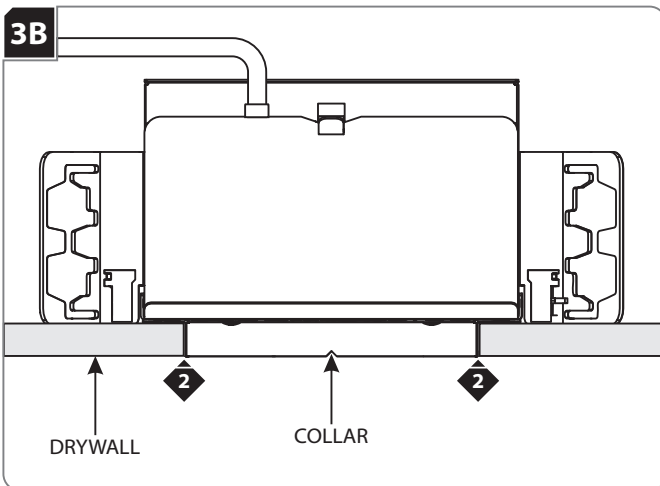

- 2** Align the cut out section of drywall with the collar and install drywall.

### FOR NON-IC FIXTURES ONLY

**WARNING: Risk of Fire:** The housing is not intended to be in contact with or covered with combustible materials and insulation. Do not install insulation within 3 inches of the housing sides or above in such a manner to entrap heat.

## Install Plaster Ring (For Flangeless Versions)

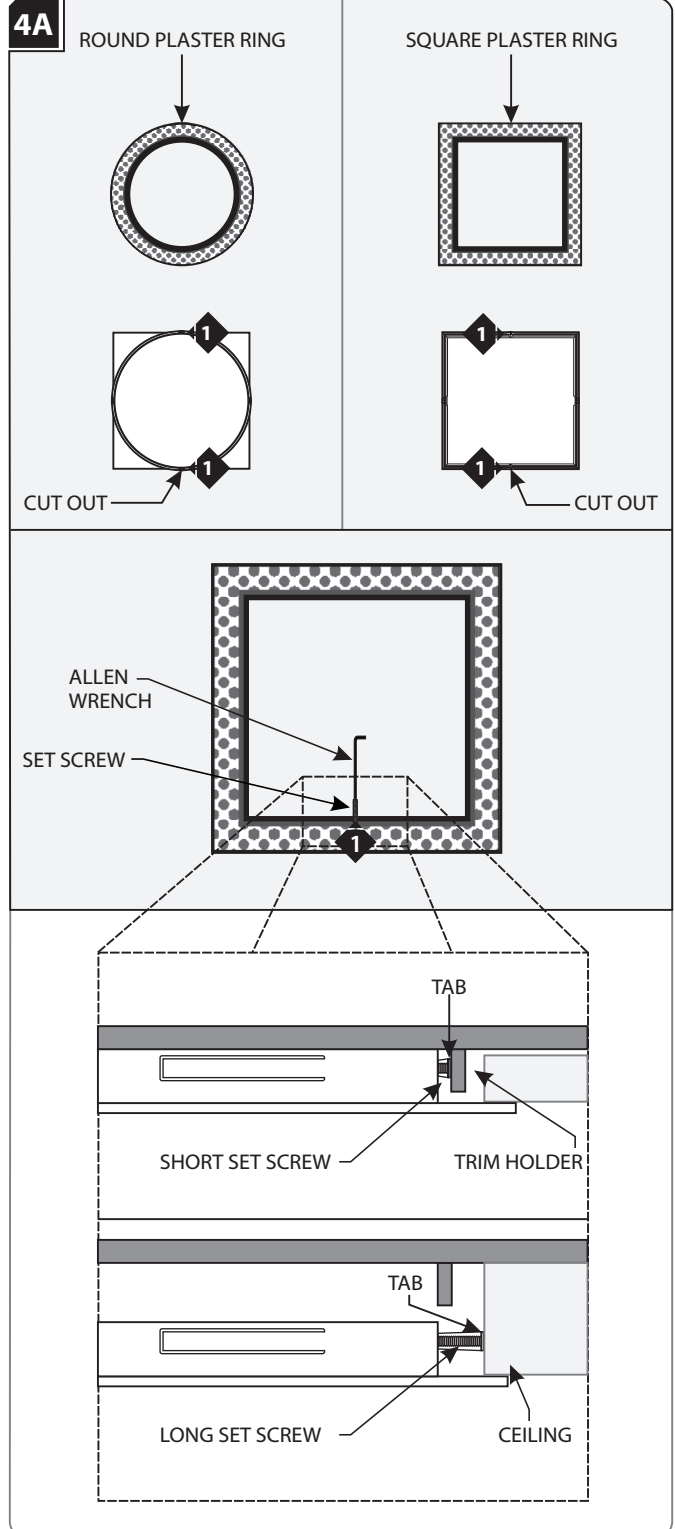

- 1** Insert the plaster ring completely into the collar/ceiling and secure them in place with the provided set screws and Allen wrench.

**NOTE:** Longer set screws have been provided for instances where the plaster ring does not reach the collar and must be secured to the inside of the ceiling cutout. Use the short set screws if the trim is installed in the collar.

**4C**

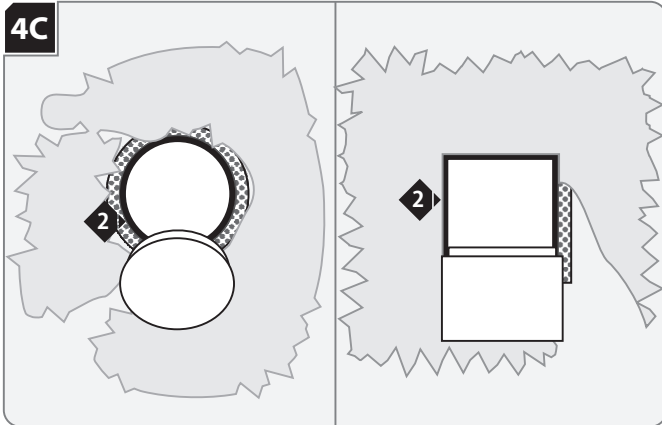

- 2 Plug the collar with the provided dust shield.
- 3 Properly plaster onto the plaster ring and drywall.

**4D**

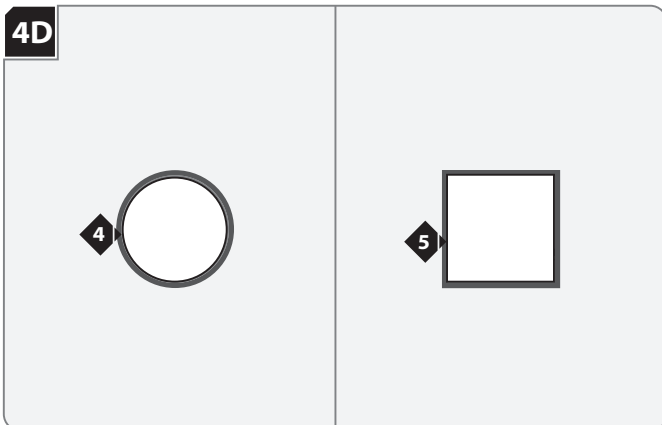

- 4 Finish around the trim to match drywall.

## Notes

