

# Round or Square Element 4" Pro Series Housing with Emergency Battery Backup in Wood Ceilings

E4P\_WC\_DE- 1.1



**CAUTION - RISK OF FIRE**  
This product must be installed in accordance with the applicable installation code by a person familiar with the construction and operation of the product and the hazards involved.  
**Use minimum 90°C supply conductors.**

**GENERAL PRODUCT INFORMATION:** 

This product is suitable for indoor locations.

This product can be dimmed with a standard electronic dimmer.

**SAVE THESE INSTRUCTIONS!**

This instruction shows a typical installation.

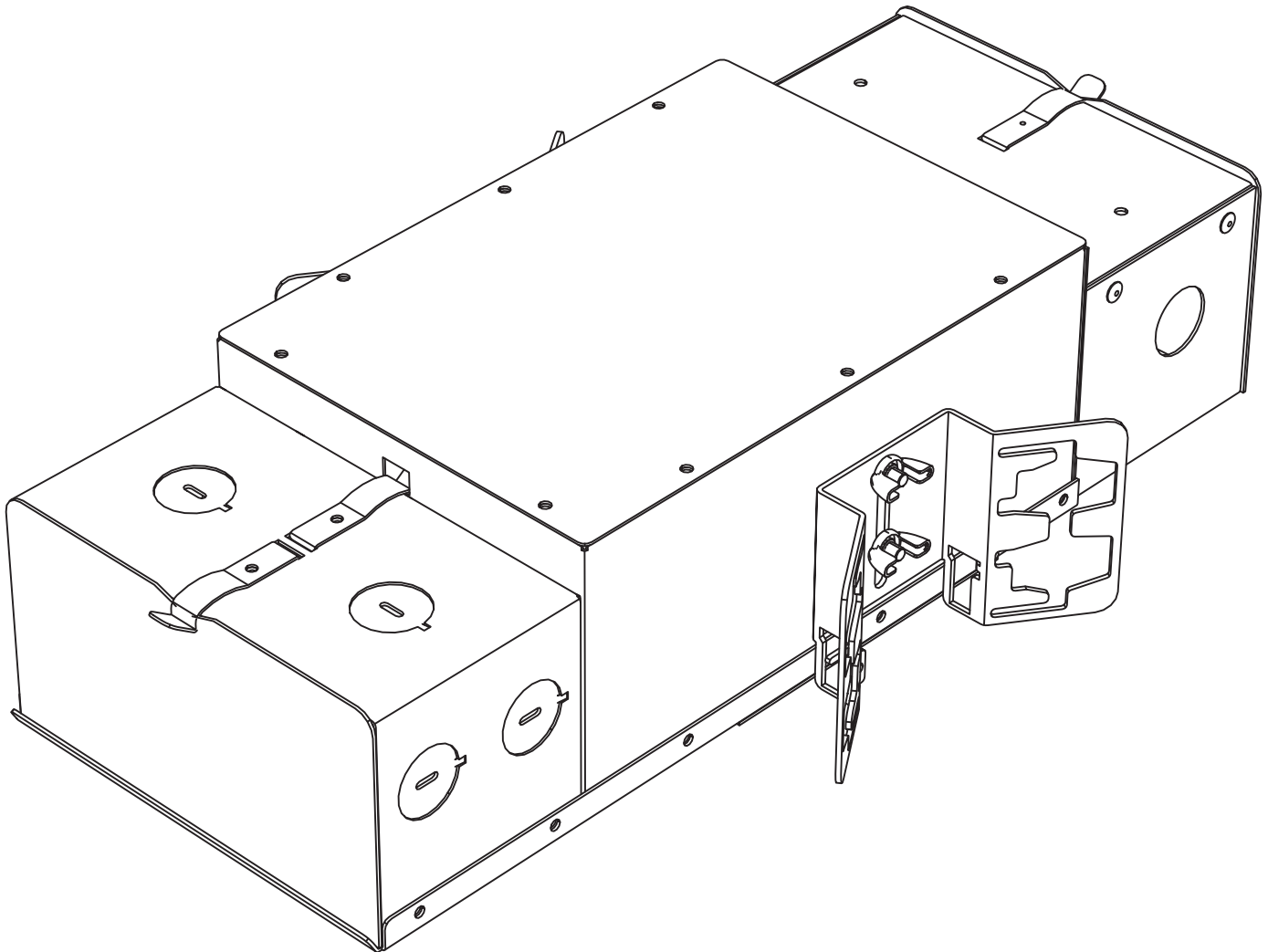

**TECH LIGHTING**  
7400 Linder Ave., Skokie, IL 60077  
T 847.410.4400 | F 847.410.4500  
www.techlighting.com

## Install the Housing with Butterfly Brackets

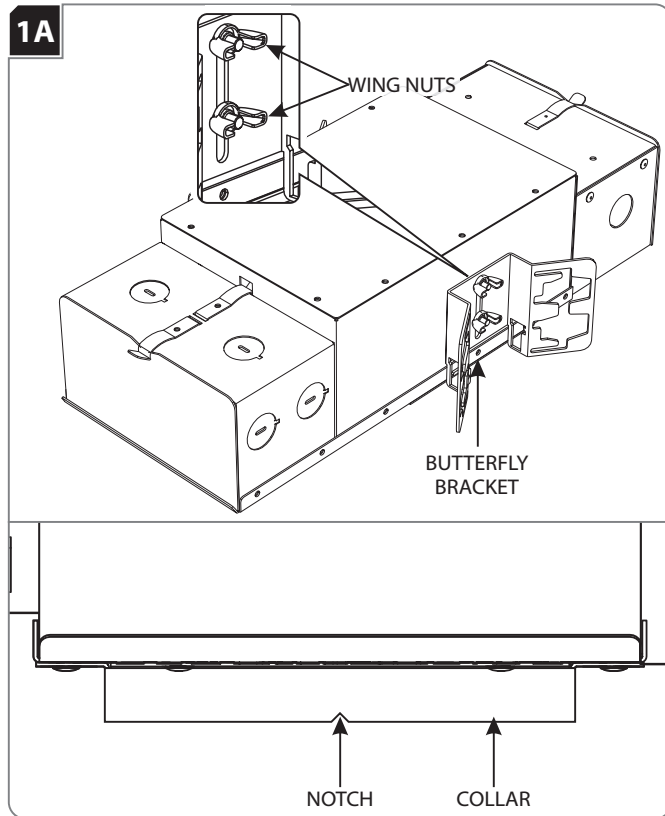

- 1 Slightly loosen the wing nuts located on the side of the housing to slide the butterfly bracket up or down.
- 2 After achieving the proper location, tighten the wing nuts to secure the butterfly bracket in place.
- 3 Repeat steps 1 and 2 on for the other butterfly bracket.
- 4 Utilize the butterfly brackets to install the housing in accordance with local electrical codes.

**NOTE:** Notches in the collar can be used to align multiple housings using a laser

## Connect Power to the Housing

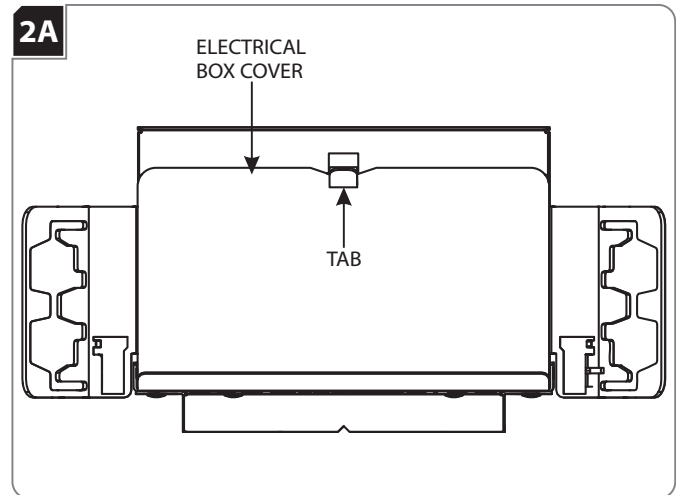

- 1 Push the tab on the housing electrical box up and remove the electrical box cover.

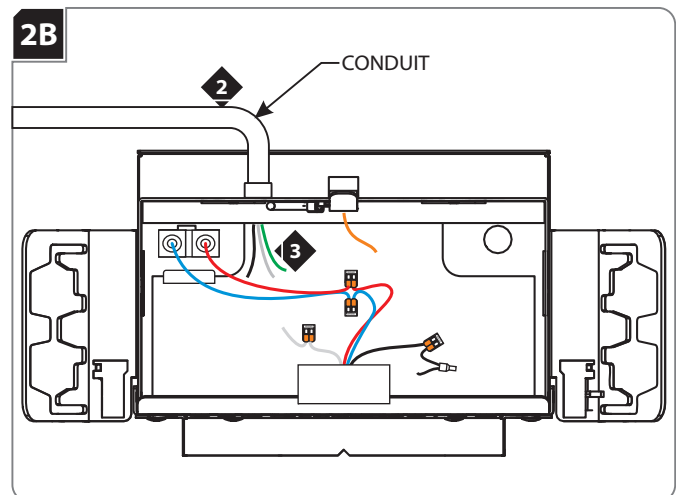

- 2 Install the conduit to the housing electrical box.
- 3 Run the power line wires into the housing electrical box.
- 4 Use the appropriate wiring diagram on the following pages to wire your fixture accordingly.

**NOTE:** When a fixture is installed in a location that requires servicing from below the ceiling through the fixture aperture, the branch circuit connections need to be able to be brought out through the aperture. To accomplish this, an NM type cable in conjunction with snap-in/push-in connectors must be used and a 12" service loop must be left available outside of the fixture housing wiring compartment to allow additional branch circuit wiring to be pulled through the snap-in/push-in connector and extended out through the aperture below ceiling level.

**WARNING: RISK OF FIRE:** When using the housing electrical box for power feed through, use MAX 4 - #12 AWG, or 6 - #14 AWG branch circuit wires.

# EMERGENCY NON-IC LABELED FIXTURE WIRING

## Standard Driver Wiring

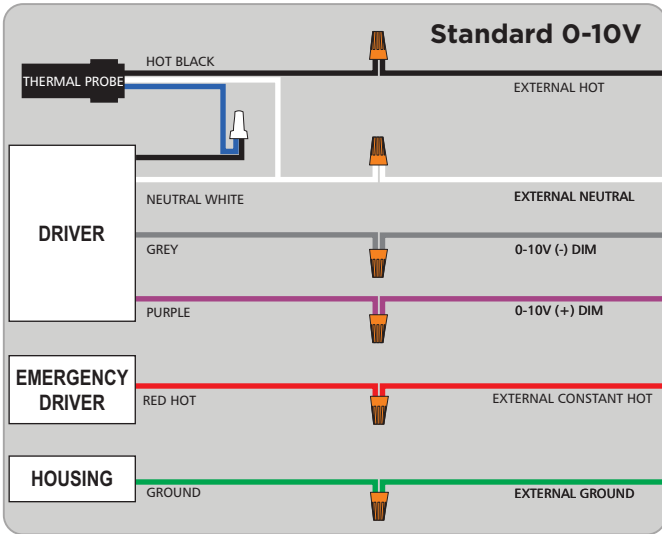
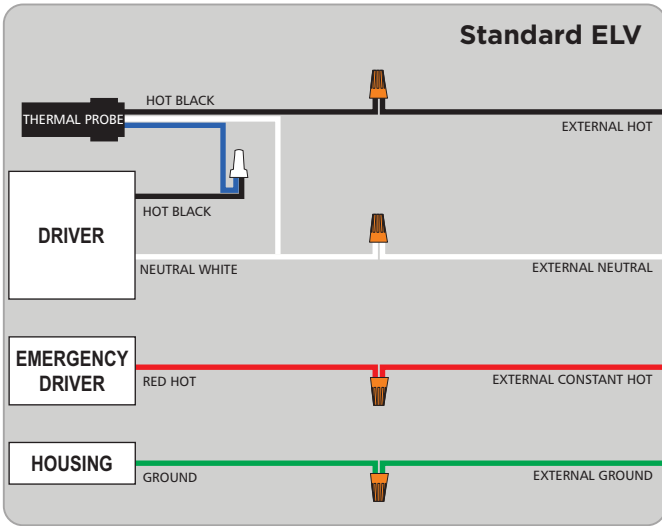

## Hi-Lume Driver Wiring

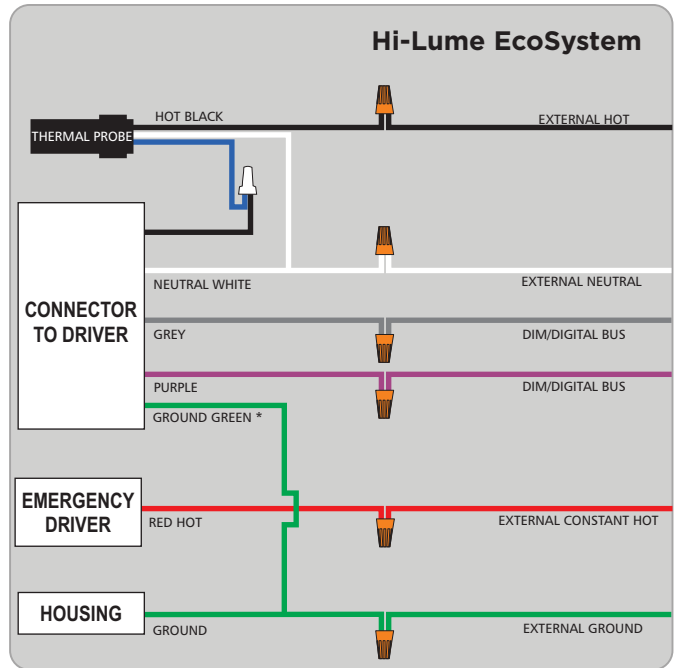
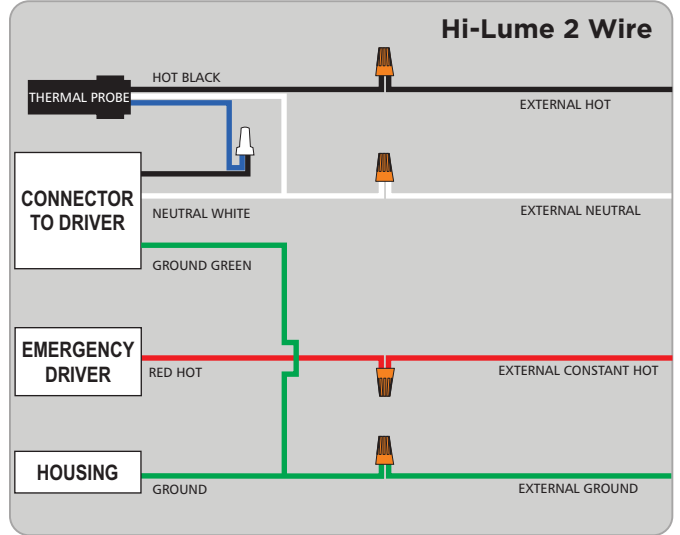

\* If green/ground connection is available, wire to ground.

# EMERGENCY NON-IC LABELED FIXTURE WIRING cont.

## EldoLED Driver Wiring

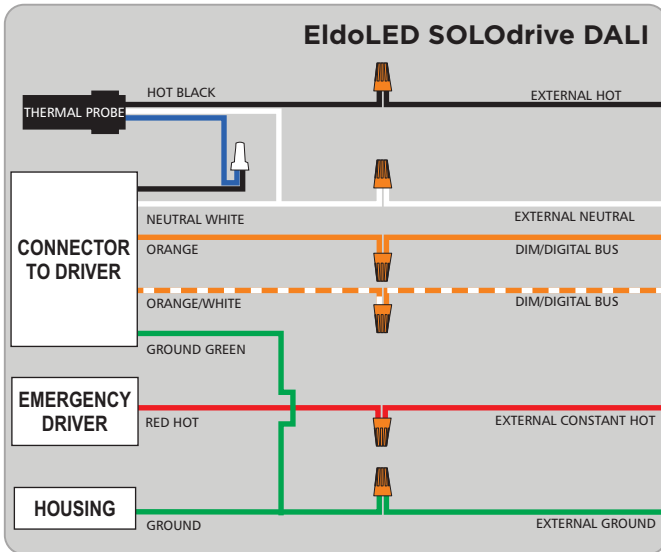
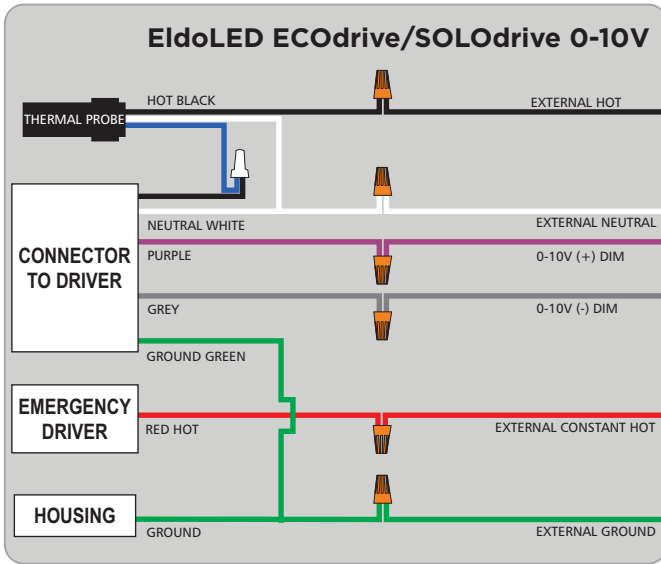

## EldoLED Tunable White Wiring

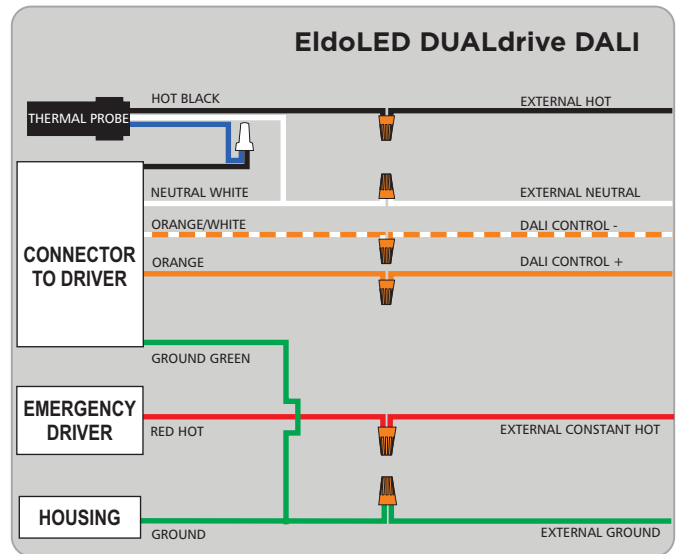
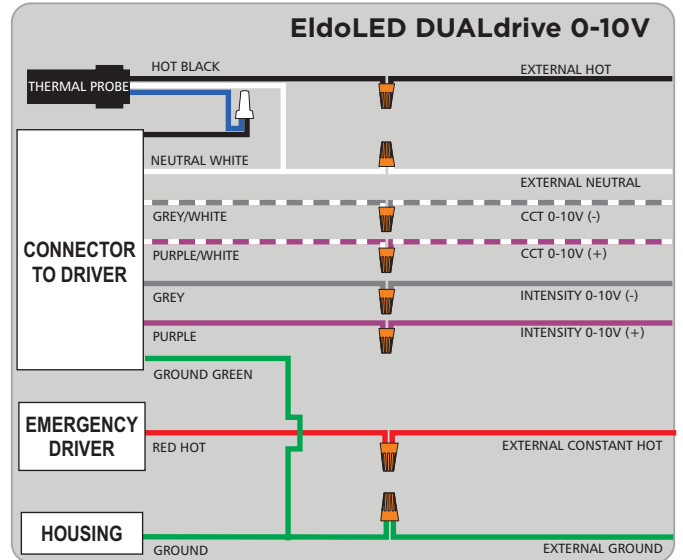

## Install the Ceiling

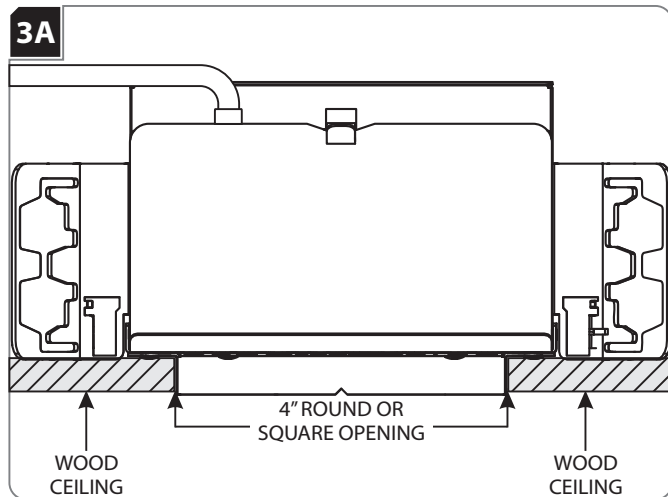

- 1 Use a 4" hole saw or mill a 4" square opening in the wood.

## Prepare for Trim Installation

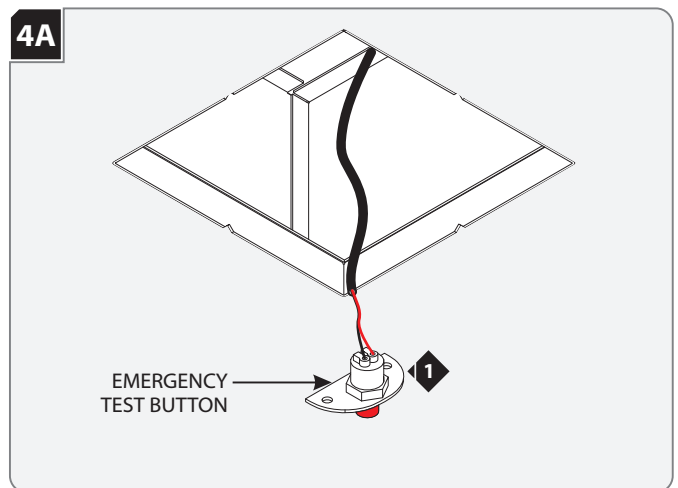

- 1 Make sure to leave the Emergency Test Button accessible for trim installation.
- 2 Refer to trim instructions for installation.

## Notes

## Notes

