

ELEMENT™ 3" LED

LOW-PROFILE FIXED DOWNLIGHT

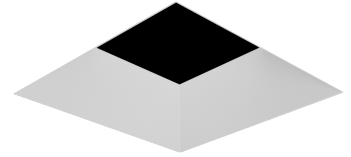

SHOWN IN FLANGELESS BEVEL SQUARE

The ELEMENT 3" LED Low-Profile Fixed Downlight is a cost-effective alternative for shallow ceiling plenum installations. Providing a beautiful architectural appearance and high performance, this fixed downlight is designed with a shallow housing at 3.4" tall for shallow ceiling installations. For a coordinating aesthetic, trims match the ELEMENT 3" platform. Ideal for space constrained environments such as elevators and healthcare soffits. Trim options include flanged or flangeless and flangeless in wood ceiling.

- Trims match the ELEMENT 3" platform
- 1-step for static white 2700K, 3000K, and 3500K; and 2-step for all other configurations
- Solite Soft Focus lens option
- LED module and optics are modular for ease of replacement
- 3.4" tall housing for shallow plenums, 7" x 12" footprint for narrow spaces
- Includes integral junction box approved for branch circuit through wiring

LUMEN/CBCP MULTIPLIERS

CCT	80 CRI MULTIPLIER	90 CRI MULTIPLIER
2200K	—	0.60
2400K	—	0.83
2700K	1.12	0.98
3000K	1.18	1.00
3500K	1.22	1.01

Lumen output will vary by CCT and CRI. See photometric charts for output information.

SPECIFICATIONS

	STATIC WHITE				WARM DIM	
	HIGH OUTPUT		LOW OUTPUT		HIGH OUTPUT	LOW OUTPUT
DELIVERED LUMENS	1697	1440	1303	1106	1225	941
WATTS	16	16	12	12	16	12
EFFICACY	106	90	109	92	77	78
CRI	80+	90+	80+	90+	90+	
CBCP	10° - 24,575 18° - 5,639 25° - 5,033 40° - 2,739 60° - 1,699 80° - 492				18° - 4,739 25° - 4,221 40° - 2,328 60° - 1,444 80° - N/A	
CCT	2200K, 2400K, 2700K, 3000K, or 3500K				3000K-1800K	
COLOR CONSISTENCY	1-step (2-step for 2200K, 2400K)				2-step	
VOLTAGE	120V or 277V					
DIMMING ¹	Standard reverse-phase, forward-phase, TRIAC, and 0-10V dimming down to 1%					
POWER SUPPLY	Constant current driver with +.9 power factor and +80% efficiency					
OPTICS	10°, 18°, 25°, 40°, 60° TIR, or 80°				18°, 25°, 40°, 60° TIR, or 80°	
CEILING APPEARANCE	Flanged, flangeless, or flangeless in wood ceiling					
CEILING THICKNESS	Flanged: Up to 2-1/2" Flangeless: No ceiling thickness limitations Flangeless in wood ceiling: 1/2" to 1-1/2" Note: Thicker ceilings impact light cutoff					
CEILING APERTURE	3-7/8" ceiling cutout					
HOUSING	IC Airtight, Chicago Plenum. IC suitable up to R60 spray foam insulation. Sauna/steam-room use available only with combination of H shower trim, LO low output housing and S IC Airtight housing rating.					
CONSTRUCTION	Housing: Heavy-gauge, cold-rolled steel Trim: Die-cast aluminum					
FINISH	Housing: Black powder coat Trim: Antique Bronze, Black, Satin Nickel, or White (paintable)					
GENERAL LISTINGS	ETL Listed. Damp Location. Shower version Wet Listed.					
CALIFORNIA TITLE 24	Registered CEC Appliance Database. Can be used to comply with CEC 2019 Title 24 Part 6 (JA8-2016, JA8-2019) (for 90 CRI versions).					
L70	50,000 hours min					
WARRANTY ²	5 years					

Data in chart reflect 3000K/90 CRI values unless noted.

Custom output/custom RAL/custom CCT available, contact Quotes Department

Ordering grids available on page 2.

¹See visualcomfort.com for dimmer compatibility.

²Visit visualcomfort.com for specific warranty limitations and details.

ELEMENT™ 3" LED

LOW-PROFILE FIXED DOWNLIGHT

ORDERING GRIDS

HOUSING

PRODUCT	CEILING APPEARANCE	LAMP	CRI/CCT	BEAM SPREAD	FUNCTION	HOUSING RATING	DRIVER
E3R ELEMENT 3" ROUND	LF FLANGELESS	-LH HIGH OUTPUT, 16W ²	827 80 CRI, 2700K, 1-STEP	0 10° ⁴	D DOWNLIGHT	S LOW-PROFILE IC AIRTIGHT	INTEGRATED DRIVERS 120V/277V UNIVERSAL PHASE/0-10V 1% (LEAVE BLANK) ⁶
E3S ELEMENT 3" SQUARE	FF FLANGED	-LO LOW OUTPUT, 12W ³	830 80 CRI, 3000K, 1-STEP	1 18°			
	WC WOOD CEILING ¹		835 80 CRI, 3500K, 1-STEP	2 25°			
			922 90 CRI, 2200K, 2-STEP	4 40°			
			924 90 CRI, 2400K, 2-STEP	6 60°			
			927 90 CRI, 2700K, 1-STEP	8 80° ⁵			
			930 90 CRI, 3000K, 1-STEP				
			935 90 CRI, 3500K, 1-STEP				
			WD 90 CRI, 3000-1800K, WARM DIM, 2-STEP				

Trims are required and must be ordered separately.

For dimming details, refer to dimmer compatibility chart.

¹WC - Wood ceiling option accommodates flangeless trims only.

²LH - High output available for wet applications. Not rated for sauna/steam-room.

³LO - Sauna/steam-room use available only with combination of H shower Trim, LO low output housing, and S IC Airtight housing rating.

⁴0 - 10° optic has a unique LED module not available with warm dim. To change optics from 10° to 18°, 25°, 40°, 60°, or 80° a new LED module is required; please contact Customer Service.

⁵8 - 80° beam spread must be used with 80° bevel (B8) style trim.

⁶Universal dimming is reverse-phase, forward-phase, TRIAC and 0-10V. 277V is only compatible with 0-10V dimming.

TRIM

PRODUCT	CEILING APPEARANCE	STYLE	APERTURE	FINISH
E3R ELEMENT 3" ROUND	L FLANGELESS	B BEVEL	-O NO LENS	Z ANTIQUE BRONZE
E3S ELEMENT 3" SQUARE	F FLANGED UP TO 1" CEILING THICKNESS	F FLAT	-H SHOWER ^{3,4}	B BLACK
	F15 FLANGED 1.1"-1.5" CEILING THICKNESS ¹	B8 80° BEVEL ^{1,2}	-L LENSED ⁴	S SATIN NICKEL
	F20 FLANGED 1.6"-2.0" CEILING THICKNESS ¹			W WHITE
	F25 FLANGED 2.1"-2.5" CEILING THICKNESS ¹			

Wood ceiling option accommodates flangeless trims only.

¹B8 - 80° bevel trim accommodates ceiling thickness of up to 1" and is not compatible with F15, F20, or F25 flanged trim.

²B8 - 80° bevel style trim can only be used with 80° (B) housing and shower aperture (-H).

³H - Sauna/steam-room use available only with combination of H shower trim, LO low output housing, and S IC Airtight housing rating.

Shower lens includes a gasket.

⁴H, L - Lensed products come with Solite Soft Focus lens.

PLASTER PLATES

PRODUCT ¹	
150E3RPPLT-2	3" PLASTER PLATE ROUND DIE-CAST METAL ¹
150E3SPPLT-2	3" PLASTER PLATE SQUARE DIE-CAST METAL ¹
150E3RTPPLT-W	3" PLASTER PLATE ROUND SHEET METAL ²
150E3STPPLT-W	3" PLASTER PLATE SQUARE SHEET METAL ²

Plaster plates are used to convert flanged housings into flangeless housings.

¹Ships standard with flangeless housings. Round not compatible with Lutron Hi-lume or eldoLED drivers.

²Optional, thinner, meshed sheet metal mud plates available for minimized plaster feathering to meet installer preference. Round not compatible with Lutron Hi-lume or eldoLED drivers. Square not compatible with eldoLED drivers.

LENSES/LOUVERS

PRODUCT ¹	
140MR16SF	SOLITE SOFT FOCUS LENS
140MR16SB	SANDBLASTED LENS
140MR16LL	LINEAR SPREAD LENS
140MR16DF	DIFFUSER SPREAD LENS
EL2RHCBK	EGGCRATE/HEXCELL LOUVER

¹For additional lenses, louvers, optical controls and accessories, reference visualcomfort.com. Lens/louvers mounted to lamp assembly only (max 2).

PREMIUM LENS HOLDER

PRODUCT	LENSES
240E3LENSHLDR	1 ONE LENS 2 TWO LENSES

240E3LENSHLDR

Provides more secure mounting of additional lenses than the lens holder that ships with each fixture. Not compatible with the 10° beam spread or Xicato high output lamp modules.

FROSTED BOROSILICATE LENS KIT

PRODUCT	
240E3SBLSP-B	BOROSILICATE LENS KIT E3 SQUARE BEVEL TRIM
240E3SQLSP-B	BOROSILICATE LENS KIT E3 SQUARE FLAT TRIM
240E3RBLSP-B	BOROSILICATE LENS KIT E3 ROUND BEVEL TRIM
240E3RDLSP-B	BOROSILICATE LENS KIT E3 ROUND FLAT TRIM

Includes frosted borosilicate lens, lens spring, and screws to mount to ELEMENT 3" trim.

REPLACEMENT OPTICS

PRODUCT	BEAM SPREAD
353E4LEDCOPT	18 18° 25 25° 40 40° 60 60°

353E4LEDCOPT

18, 25, 40, and 60 degree optics are field-interchangeable.

ELEMENT™ 3" LED

LOW-PROFILE FIXED DOWNLIGHT

TRIMS

FLANGED

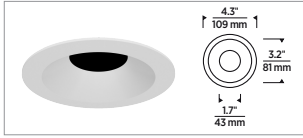

ROUND BEVEL

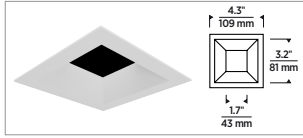

SQUARE BEVEL

FLANGELESS

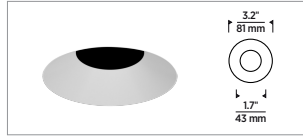

ROUND BEVEL

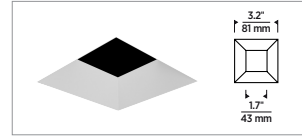

SQUARE BEVEL

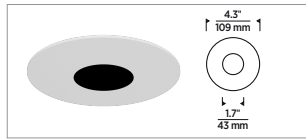

ROUND FLAT

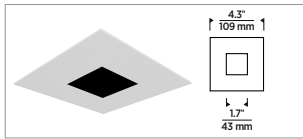

SQUARE FLAT

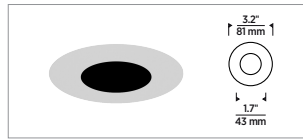

ROUND FLAT

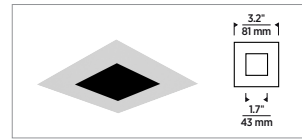

SQUARE FLAT

FINISH



ANTIQUE BRONZE



BLACK



SATIN NICKEL



WHITE (PAINTABLE)

FLANGELESS IN WOOD CEILING



SHOWN IN ANTIQUE BRONZE

See installation instruction sheet on visualcomfort.com.

LENS OPTION



SHOWN WITH AND WITHOUT A LENS

WARM DIM CURVE

CCT vs. Forward Current, $T_c=25^\circ\text{C}$

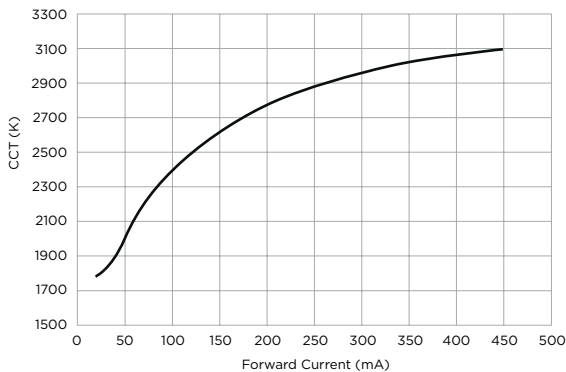

HOUSING

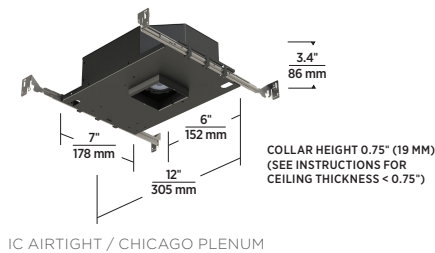

ELEMENT™ 3" LED

LOW-PROFILE FIXED DOWNLIGHT

PLASTER PLATES

INCLUDED DIE-CAST

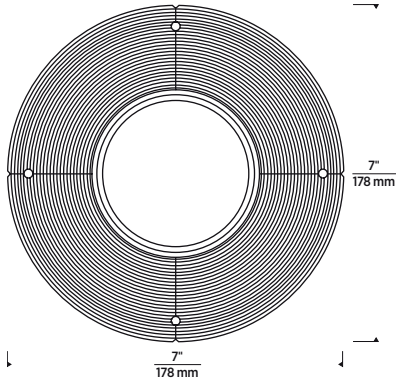

ROUND DIE-CAST (INCLUDED FOR FLANGELESS INSTALLATION)

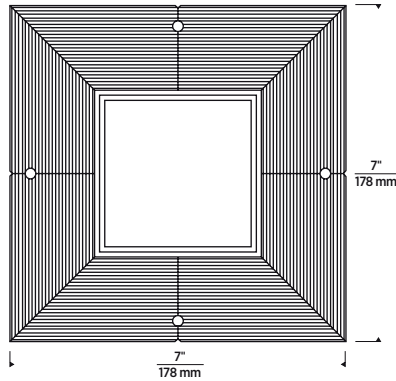

SQUARE DIE-CAST (INCLUDED FOR FLANGELESS INSTALLATION)

OPTIONAL SHEET METAL

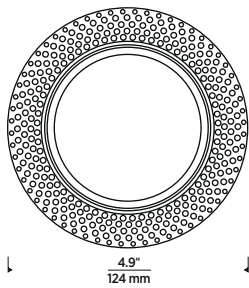

ROUND SHEET METAL (OPTIONAL FOR FLANGELESS INSTALLATION)

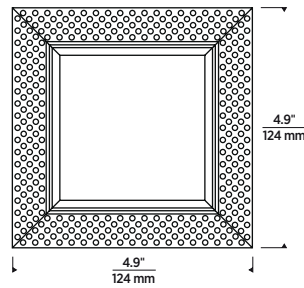

SQUARE SHEET METAL (OPTIONAL FOR FLANGELESS INSTALLATION)

FLANGELESS IN WOOD CEILING TRIM ADAPTER

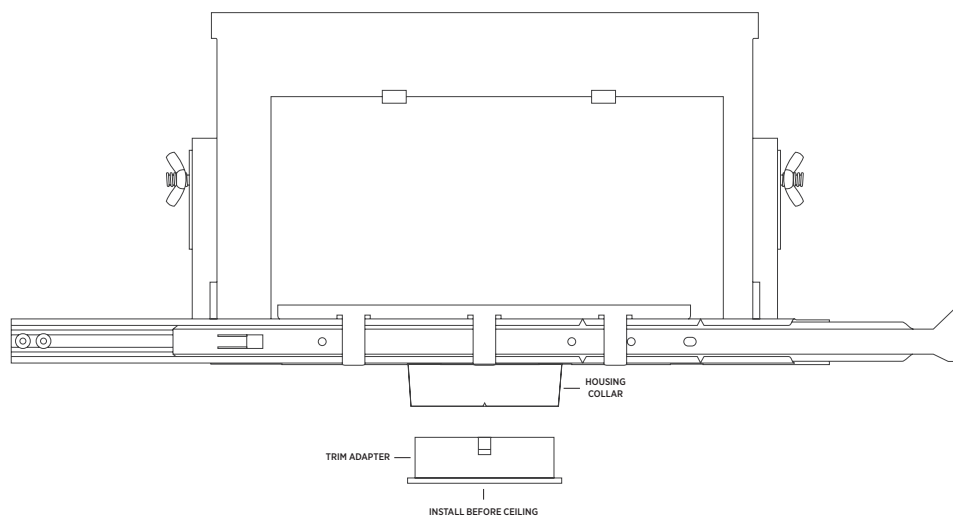

TRIM ADAPTER INSTALLED



TRIM ADAPTER FLUSH

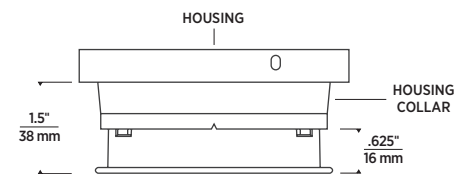

TRIM ADAPTER EXTENDED

Wood ceiling housings ("WC" designation in the ordering grid) ship with an adjustable trim adapter that inserts into the housing aperture and allows standard ELEMENT 3" flangeless trims to achieve a truly flangeless, flush ceiling appearance in special applications such as wood or stone installation. For use in new construction. Consult installation instructions regarding plenum requirements and ceiling thickness ratios.

ELEMENT™ 3" LED









LOW-PROFILE FIXED DOWNLIGHT

TRIM-MOUNTED REFLECTORS

ELEMENT Specular Reflectors reduce glare while creating a clean, quiet ceiling appearance. Available finishes include anodized silver for a decorative accent or anodized black for an ultimate quiet ceiling aesthetic. These beautiful trim accessories have been specifically designed to minimize any effect on light performance, color and output. Specular Reflectors are available for both adjustable and fixed downlights and are compatible with ELEMENT 3" trims and housings.

- Can be easily installed or removed
- Assembles to existing trim
- Compatible with Fixed and Adjustable Housings
- Finish Options: Anodized Black (B) or Anodized Silver (S)

SPECIFICATIONS

COMPATIBLE TRIMS		NON-SLOTTED (FOR FIXED)	
	3" round, flanged, flat		E3TREFNS1 (B OR S)
	3" square, flanged, flat		E3TREFNS3 (B OR S)
	3" round, flangeless, flat		E3TREFNS4 (B OR S)
	3" square, flangeless, flat		E3TREFNS3 (B OR S)

Not compatible with lensed trims.

ORDERING GRID

E3 TRIM-MOUNTED REFLECTORS

PRODUCT	STYLE	FINISH
E3TREF	NS1 NON-SLOTTED	B ANODIZED BLACK
	NS3 NON-SLOTTED	S ANODIZED SILVER
	NS4 NON-SLOTTED	

E3TREF

Reflectors are placed on top of the inside of the trim of affixed via screws (only if provided).

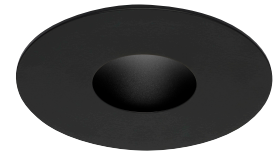

SHOWN IN ANODIZED BLACK (BELOW CEILING VIEW)

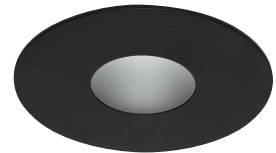

SHOWN IN ANODIZED SILVER (BELOW CEILING VIEW)



SHOWN IN ANODIZED BLACK (TRIM MOUNTED)

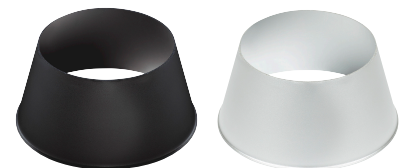

SHOWN IN ANODIZED BLACK AND SILVER (REFLECTOR ONLY)

ELEMENT™ 3" LED

LOW-PROFILE FIXED DOWNLIGHT

PHOTOMETRICS

Description: 3" LED Module
10° Beam
90 CRI, 3000K

Input Power: 18.2W
Input Power Factor: 0.99

Absolute Luminous Flux (Lumens): 987
Lumen Efficacy (Lumens per Watt): 54.2

Description: 3" LED Module
18° Beam
90 CRI, 3000K

Input Power: 15.8W
Input Power Factor: 0.98

Absolute Luminous Flux (Lumens): 1278
Lumen Efficacy (Lumens per Watt): 80.9

Description: 3" LED Module
25° Beam
90 CRI, 3000K

Input Power: 15.8W
Input Power Factor: 0.98

Absolute Luminous Flux (Lumens): 1421
Lumen Efficacy (Lumens per Watt): 89.9

Output difference between CCTs - 5%, CRIs - 15%.

ANGLE	0°	45°	90°
0°	24575	24575	24575
5°	12004	10898	12296
10°	1418	1275	1517
15°	355	332	340
20°	171	165	154
25°	90	85	87
30°	52	48	49
35°	33	31	32
40°	21	19	19
45°	10	11	8
50°	3	6	3
55°	2	2	2
60°	1	1	1
65°	0	0	0
70°	0	0	0
75°	0	0	0
80°	0	0	0
85°	0	0	0
90°	0	0	0

ANGLE	0°	45°	90°
0°	5546	5546	5546
5°	4951	5044	4838
10°	3208	3326	3167
15°	1748	1859	1721
20°	882	1028	871
25°	395	485	380
30°	171	195	167
35°	83	84	81
40°	49	52	50
45°	29	34	30
50°	14	22	13
55°	12	15	11
60°	11	12	9
65°	7	10	6
70°	6	6	6
75°	5	6	5
80°	5	5	5
85°	5	5	5
90°	4	5	5

ANGLE	0°	45°	90°
0°	4966	4966	4966
5°	4647	4710	4525
10°	3677	3750	3542
15°	2292	2346	2143
20°	1103	1188	986
25°	465	559	417
30°	211	240	187
35°	98	100	89
40°	53	56	50
45°	30	35	29
50°	16	22	14
55°	11	13	10
60°	9	9	8
65°	8	7	7
70°	7	6	6
75°	6	6	6
80°	6	5	5
85°	5	5	5
90°	5	5	5

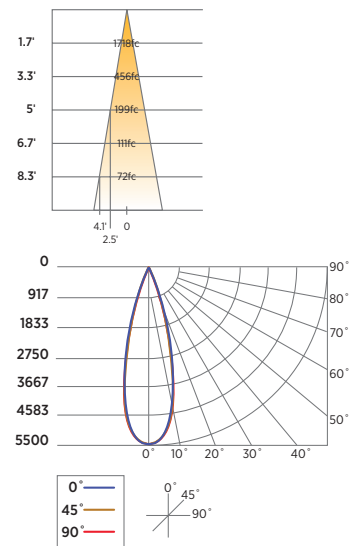
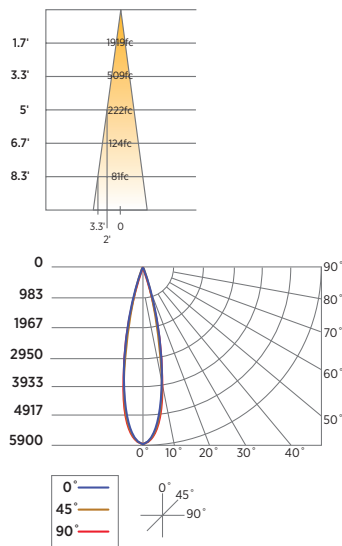
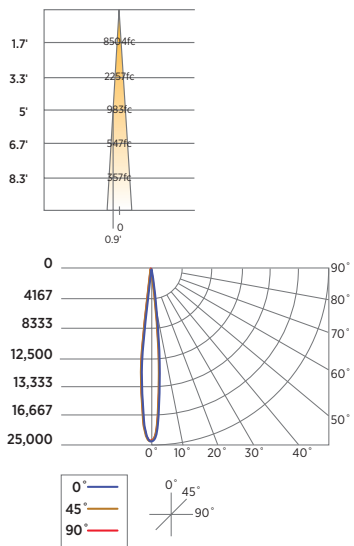

ELEMENT™ 3" LED

LOW-PROFILE FIXED DOWNLIGHT

PHOTOMETRICS

Description: 3" LED Module
40° Beam
90 CRI, 3000K

Input Power: 15.8W

Input Power Factor: 0.98

Absolute Luminous Flux (Lumens): 1440

Lumen Efficacy (Lumens per Watt): 91.1

Description: 3" LED Module
60° Beam
90 CRI, 3000K

Input Power: 15.7W

Input Power Factor: 0.98

Absolute Luminous Flux (Lumens): 1343

Lumen Efficacy (Lumens per Watt): 85.5

Description: 3" LED Module
80° Beam
90 CRI, 3000K

Input Power (Watts): 16.2

Input Power Factor: 0.99

Absolute Luminous Flux (Lumens): 819

Lumen Efficacy (Lumens per Watt): 51

Output difference between CCTs - 5%, CRIs - 15%.

ANGLE	0°	45°	90°
0°	2729	2729	2729
5°	2686	2706	2649
10°	2503	2538	2439
15°	2147	2183	2100
20°	1617	1683	1572
25°	915	1000	904
30°	388	434	375
35°	153	162	157
40°	70	77	71
45°	31	41	32
50°	10	21	11
55°	7	10	7
60°	4	6	4
65°	3	4	3
70°	3	3	13
75°	2	3	2
80°	2	2	2
85°	2	2	2
90°	1	2	2

ANGLE	0°	45°	90°
0°	1699	1699	1699
5°	1654	1654	1654
10°	1548	1548	1548
15°	1403	1403	1403
20°	1163	1163	1163
25°	854	854	854
30°	580	580	580
35°	374	374	374
40°	219	219	219
45°	112	112	112
50°	48	48	48
55°	23	23	23
60°	9	9	9
65°	7	7	7
70°	6	6	6
75°	6	6	6
80°	5	5	5
85°	5	5	5
90°	5	5	5

ANGLE	0°	45°	90°
0°	492	492	492
5°	486	487	489
10°	474	474	477
15°	452	452	456
20°	424	423	428
25°	388	387	394
30°	345	345	351
35°	296	297	303
40°	244	246	251
45°	193	198	197
50°	144	153	146
55°	100	112	101
60°	62	75	60
65°	27	44	25
70°	7	16	7
75°	4	5	4
80°	3	3	2
85°	1	1	1
90°	0	0	0

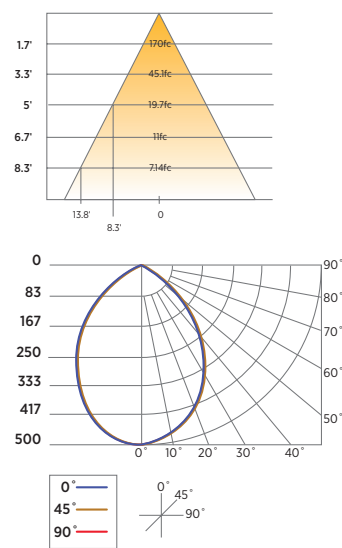
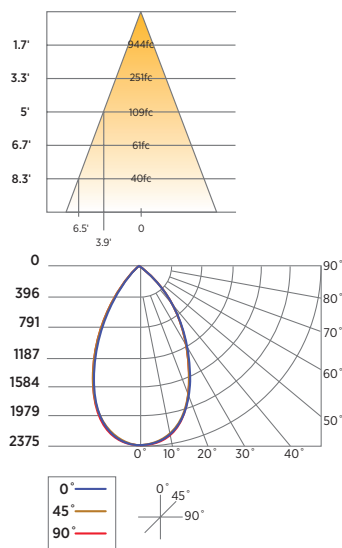
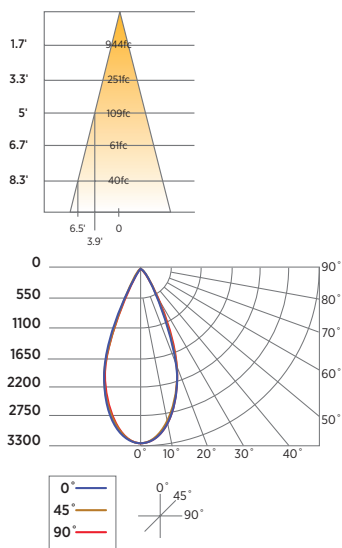

ELEMENT™ 3" LED

LOW-PROFILE FIXED DOWNLIGHT

PROJECT INFORMATION

JOB NAME AND INFORMATION

FIXTURE TYPE AND QUANTITY

NOTES
