

ELEMENT™ 4" LED

ADJUSTABLE DOWNLIGHT

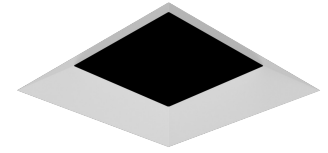

SHOWN IN FLANGELESS BEVEL SQUARE

The ELEMENT 4" Next Generation Adjustable recessed downlight features full adjustability with lockable, tool-free, hot aiming. ELEMENT's patented high/low lamp positioning allows the LED to be positioned closer to the aperture for maximum light output and efficiency or higher in the ceiling to minimize glare and flash on the trim. Options include premium warm dimming, Tunable White, Xicato and Xicato Artist Series LED modules. Trim options include flanged or flangeless and flangeless wood ceiling.

- Housing reduced by 54%
- Tool-free, aiming/locking: 0-40° tilt, 361° rotation
- Patented high/low lamp positioning
- 1-step for static white 2700K, 3000K, and 3500K; and 2-step for all other configurations
- Standard dimming down to 1%
- Trim reflector options
- Solite Soft Focus lens option

LUMEN/CBCP MULTIPLIERS

CCT	80 CRI MULTIPLIER	90 CRI MULTIPLIER
2200K	—	0.51
2400K	—	0.71
2700K	0.95	0.80
3000K	1.00	0.85
3500K	1.05	0.90

Lumen output will vary by CCT and CRI. See photometric charts for output information.

SPECIFICATIONS

	STATIC WHITE			XICATO		WARM DIM		TUNABLE WHITE	
	MAX OUTPUT	HIGH OUTPUT	LOW OUTPUT	STANDARD SERIES	ARTIST SERIES	HIGH OUTPUT	LOW OUTPUT	HIGH OUTPUT (5000K)	HIGH OUTPUT (4000K)
DELIVERED LUMENS	4000/3400	2900/2465	1800/1450	1575	1856	2374	1300	2157	1900
WATTS	35	29	17	19	26	31	17	28	28
EFFICACY	112/96	100/85	106/85	81	71	76	76	72	69
CRI	80+/90+			80+	95+	90+			
CBCP	10° - 19,414 (low output) 18° - 8,192 25° - 6,907 40° - 4,517 60° - 3,209			21° - 8,345 43° - 3,644 60° - 1,964	21° - 8,471 43° - 4,022 60° - 2,237	18° - N/A 25° - N/A 40° - 2,381 60° - N/A			
CCT	2200K, 2400K, 2700K, 3000K, or 3500K			2700K, 3000K, or 3500K ³		3000K-1800K		5000K-2700K	4000K-1800K
COLOR CONSISTENCY	1-step (2-step for 2200K, 2400K)			1 X 2-step		2-step			
VOLTAGE	120V or 277V								
DIMMING¹	Standard reverse-phase, forward-phase, TRIAC, and 0-10V dimming down to 1% eldoLED 0-10V or DALI-2 down to 0.1% Lutron Hi-lume EcoSystem down to 0.1%							eldoLED 0-10V or DALI-2 down to 0.1%	
POWER SUPPLY	Constant current driver with +.9 power factor and +80% efficiency								
OPTICS	Field changeable: 10°, 18°, 25°, 40°, or 60° TIR			Field changeable: 21°, 43°, or 60° Reflector		Field changeable: 18°, 25°, 40°, or 60° TIR			
ADJUSTABILITY	Lockable, hot-aiming, 0-40° tilt, 361° rotation, high/low positioning, 45° collar rotation								
CEILING APPEARANCE	Flanged, flangeless, or flangeless in wood ceiling								
CEILING THICKNESS	Flanged: Up to 2-1/2" Flangeless: No ceiling thickness limitations Flangeless in Wood Ceiling: 1/2" to 2" Note: Thicker ceilings impact light cutoff								
CEILING APERTURE	4-1/2" ceiling cutout								
HOUSING	IC Airtight, Non-IC Airtight, Chicago Plenum. IC suitable up to R60 spray foam insulation. Sauna/steam-room use available only with combination of H shower trim, LO low output housing, and I IC housing rating.								
CONSTRUCTION	Housing: Heavy-gauge, Cold-rolled steel Trim: Die-cast aluminum								
FINISH	Housing: Black Powder Coat Trim: Antique Bronze, Black, Satin Nickel, or White (paintable)								
GENERAL LISTINGS	ETL Listed. Damp Location. Shower version Wet Listed.								
CALIFORNIA TITLE 24	Registered CEC Appliance Database. Can be used to comply with CEC 2019 Title 24 Part 6 (JA8-2016, JA8-2019) (for 90 CRI versions).								
L70	50,000 hours min								
WARRANTY²	5 years								

Data in chart reflect 3000K/80 CRI values unless noted.
Custom output/custom RAL/custom CCT available, contact Quotes Department

Ordering grids available on page 2.

Accepts two optical controls and an optional trim-mounted lens.

¹See visualcomfort.com for dimmer compatibility. LH high output and LV max output standard phase dimming down to 5% min.

²Visit visualcomfort.com for specific warranty limitations and details.

³3500K Xicato module not available for Artist series.

ELEMENT™ 4" LED

ADJUSTABLE DOWNLIGHT

ORDERING GRIDS

HOUSING

PRODUCT	CEILING APPEARANCE	OUTPUT	CRI/CCT	BEAM SPREAD	FUNCTION	HOUSING RATING	DRIVER	VOLTAGE
E4R ELEMENT 4" ROUND	L FLANGELESS F FLANGED	-LV MAX OUTPUT, 35W ²	827 80 CRI, 2700K, 1-STEP 830 80 CRI, 3000K, 1-STEP	10 10° ⁶ 18 18°	A ADJUSTABLE	I IC AIRTIGHT N NON-IC AIRTIGHT	INTEGRATED DRIVERS 120V/277V UNIVERSAL PHASE/0-10V 1% (LEAVE BLANK) ⁷	120 VOLT (LEAVE BLANK) -277 277 VOLT
E4S ELEMENT 4" SQUARE	WC WOOD CEILING ¹	-LH HIGH OUTPUT, 29W ³ -LO LOW OUTPUT, 17W ⁴	835 80 CRI, 3500K, 1-STEP 922 90 CRI, 2200K, 2-STEP 924 90 CRI, 2400K, 2-STEP 927 90 CRI, 2700K, 1-STEP 930 90 CRI, 3000K, 1-STEP 935 90 CRI, 3500K, 1-STEP WD 90 CRI, 3000-1800K, WARM DIM, 2-STEP TW52 90 CRI, 5000K-2700K, TUNABLE WHITE, 2-STEP ⁵ TW41 90 CRI, 4000K-1800K, TUNABLE WHITE, 2-STEP ⁵	25 25° 40 40° 60 60°		C CHICAGO PLENUM E EMERGENCY BATTERY (NON-IC / CHICAGO PLENUM)	-ELDO ELDOLED 0.1% 0-10V LINEAR -ELDOA ELDOLED 0.1% 0-10V LOGARITHMIC -ELDD ELDOLED 0.1% DALI-2 -ELTO ELDOLED TUNABLE WHITE 0.1% 0-10V LINEAR ⁵ -ELTD ELDOLED TUNABLE WHITE 0.1% DALI-2 ⁵ -HLECO LUTRON HI-LUME 0.1% ECOSYSTEM	
		-X XICATO, HIGH OUTPUT, 25W ⁸	I27 80 CRI, 2700K, 1X2-STEP, XICATO I30 80 CRI, 3000K, 1X2-STEP, XICATO I35 80 CRI, 3500K, 1X2-STEP, XICATO A27 95 CRI, 2700K, 1X2-STEP, XICATO ARTIST A30 95 CRI, 3000K, 1X2-STEP, XICATO ARTIST	21 21° XICATO 43 43° XICATO 60 60° XICATO				

Trims are required and must be ordered separately.

¹WC - Wood ceiling option accommodates flangeless trims only.

²LV - Max output not available with I IC housing, HLECO Lutron driver, WD warm dim, or TW tunable white. Standard phase dimming down to 5% min. LV available for wet application (not rated for sauna/steam-room).

³LH - Standard phase dimming down to 5% min. LH available for wet application (not rated for sauna/steam-room).

⁴LO - Sauna/steam-room use available only with combination of H shower trim, LO low output and I IC housing.

⁵TW52, TW41 - Tunable white only available in LH high output, only available with ELTO (0-10V, linear), or ELTD (DALI-2). I IC housing output is 15% less than N non-IC housing output.

For 0-10V logarithmic dimming consult Quotes Department.

⁶10 - Available with LO low output only. 10° beam spread has a unique LED module not available with warm dim or tunable white. Changing optics to 18°, 25°, 40°, or 60° will require a new LED module.

⁷Universal dimming is reverse-phase, forward-phase, TRIAC, and 0-10V. 277V is only compatible with 0-10V dimming.

⁸X - Xicato housings utilize dedicated standard phase, 0-10V, 120V and 277V drivers. If ordering Xicato with standard drivers (non-Lutron or eldoLED), at the end of the item number please specify:

-010 for 0-10V 120V, **-277** for phase 277V or **-010-277** for 0-10V 277. For example: E3RLF-XA2743DI-010 or E3RLF-XA2743DI-277 or E3RLF-XA2743DI-010-277. Due to the size of some of the Xicato Reflectors, it may not be feasible to tilt the fixture in the 'low' position. It is still tiltable in the 'high' position.

TRIM

PRODUCT	CEILING APPEARANCE	STYLE	APERTURE	FINISH
E4R ELEMENT 4" ROUND	L FLANGELESS	B BEVEL	-O NO LENS	Z ANTIQUE BRONZE
E4S ELEMENT 4" SQUARE	F FLANGED	F FLAT	-H SHOWER ^{1,2}	B BLACK
	F15 FLANGED 1.1"-1.5" CEILING THICKNESS		-L LENSED ²	S SATIN NICKEL
	F20 FLANGED 1.6"-2.0" CEILING THICKNESS			W WHITE
	F25 FLANGED 2.1"-2.5" CEILING THICKNESS			

¹H - Sauna/steam-room use available only with combination of H shower trim, LO low output and I IC housing. Shower lens includes a gasket.

²H, L - Lensed products come with Solite Soft Focus lens.

LENSES / LOUVERS¹

PRODUCT	LENSES / LOUVERS
140MR16SF	SOLITE SOFT FOCUS LENS
140MR16SB	SANDBLASTED LENS
140MR16LL	LINEAR SPREAD LENS
140MR16DF	DIFFUSER SPREAD LENS
EL2RHCBK	EGGCRATE/HEXCELL LOUVER

¹For additional lenses, louvers, optical controls and accessories, reference visualcomfort.com. ELEMENT allows up to two lenses or louvers per fixture.

PLASTER PLATES

PRODUCT	PLASTER PLATE
150E4RPPLT	ROUND PLASTER PLATE
150E4SPPLT	SQUARE PLASTER PLATE

Plaster plates are used to convert flanged housings into flangeless housings. Ships standard with flangeless housings.

REPLACEMENT OPTICS

PRODUCT	BEAM SPREAD
353E4LEDCOPT	18 18° 25 25° 40 40° 60 60°
353E4LEDCOPT	

REPLACEMENT REFLECTORS¹

PRODUCT	BEAM SPREAD
352LEDXREF	21 21° 43 43° 60 60°
352LEDXREF	

¹For use with Xicato modules only.

PREMIUM LENS HOLDER

PRODUCT	LENSES
240E3LENSHLDR	1 ONE LENS 2 TWO LENSES

240E3LENSHLDR

The premium, threaded lens holder provides more secure mounting of additional lenses as compared to the standard lens holder that ships with each fixture. Not compatible with the 10° beam spread or Xicato high output lamp modules.

ELEMENT™ 4" LED

ADJUSTABLE DOWNLIGHT

TRIMS

FLANGED

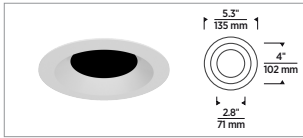

ROUND BEVEL

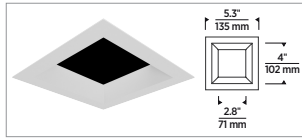

SQUARE BEVEL

FLANGELESS

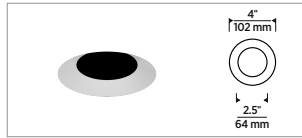

ROUND BEVEL

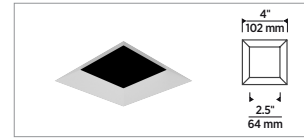

SQUARE BEVEL

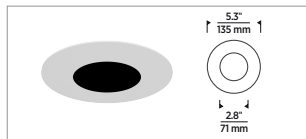

ROUND FLAT

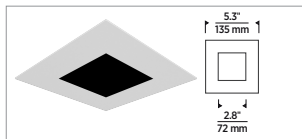

SQUARE FLAT

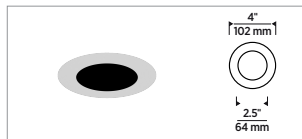

ROUND FLAT

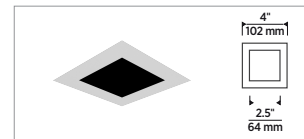

SQUARE FLAT

FINISH



ANTIQUE BRONZE



BLACK



SATIN NICKEL



WHITE (PAINTABLE)

FLANGELESS IN WOOD CEILING



SHOWN IN ANTIQUE BRONZE

See installation instruction sheet on visualcomfort.com.

LENS OPTION



SHOWN WITH AND WITHOUT A LENS

WARM DIM CURVE

CCT vs. Forward Current, $T_c=25^\circ\text{C}$

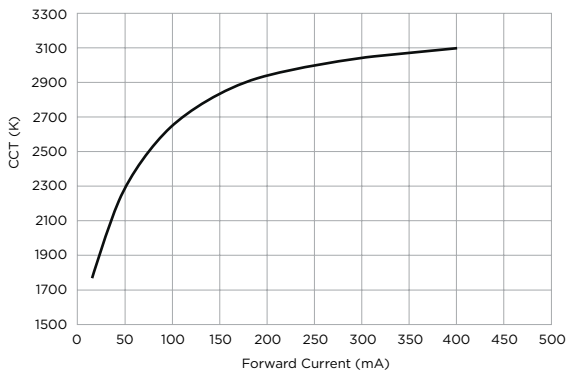

ELEMENT™ 4" LED

ADJUSTABLE DOWNLIGHT

HOUSING

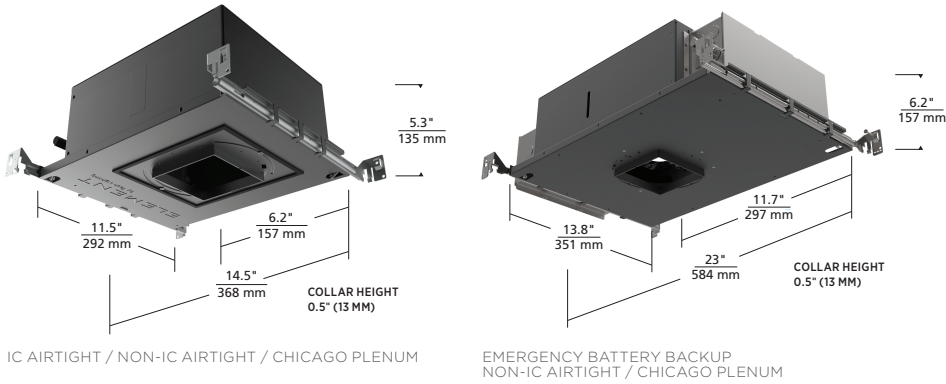

PLASTER PLATES

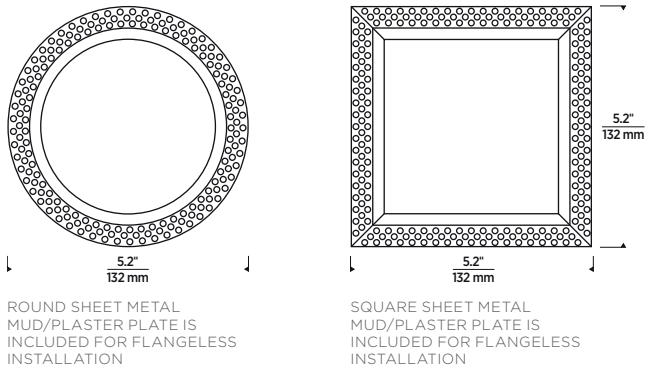

FLANGELESS IN WOOD CEILING INSTALLATION

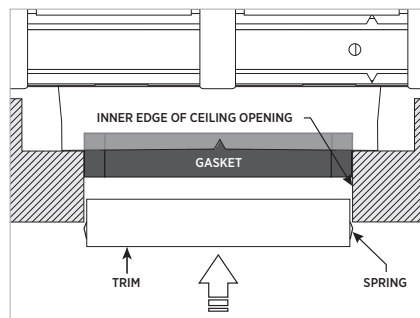















ELEMENT™ 4" LED

ADJUSTABLE DOWNLIGHT

ELEMENT Specular Reflectors reduce glare while creating a clean, quiet ceiling appearance. These beautiful trim accessories have been specifically designed to minimize any effect on light performance, color and output. Specular Reflectors are available for both adjustable and fixed downlights, and are compatible with ELEMENT 4" trims and housings.

- Can be easily installed or removed
- Mounts to existing trim
- Compatible with fixed and adjustable housings

SPECIFICATIONS

COMPATIBLE TRIMS	NON-SLOTTED (FOR FIXED ¹)	SLOTTED (FOR ADJUSTABLE)
 4" round, flanged, bevel	 E4TREFNS2B	 E4TREFS5B
 4" round, flanged, flat	 E4TREFNS1B	 E4TREFS3B
 4" round, flangeless, bevel	 E4TREFNS2B	 E4TREFS5B
 4" round, flangeless, flat	 E4TREFNS1B	 E4TREFS3B
 4" square, flanged, bevel	 E4TREFNS6B	 E4TREFS2B

Only compatible with ELEMENT 4" LED series.
 May require lamp to be placed in high position.
 Not available for ELEMENT 4" square flat trims or square flangeless bevel trims.
 Not compatible with lensed trims.
¹Non-slotted reflectors may be used in adjustable housings with the lamp assembly placed in the 0° tilt position.

ORDERING GRID

E4 TRIM MOUNTED REFLECTORS¹

PRODUCT	STYLE	FINISH
E4TREF	NS1 NON-SLOTTED	B ANODIZED BLACK
	NS2 NON-SLOTTED	
	NS6 NON-SLOTTED	
	S2 SLOTTED	
	S3 SLOTTED	
	S5 SLOTTED	
E4TREF		B

¹Not compatible with lensed trims.

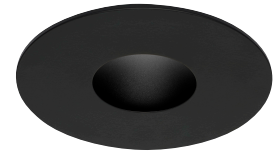

BELOW CEILING VIEW



SHOWN MOUNTED TO TRIM



REFLECTOR ONLY

ELEMENT™ 4" LED

ADJUSTABLE DOWNLIGHT

PHOTOMETRICS

Description: 4" LED Module
18° Beam, 0° Tilt,
90 CRI, 3000K

Model: E4 LED
Input Power (Watts): 32.9
Input Power Factor: 0.99
Absolute Luminous
Flux (Lumens): 2494
Lumen Efficacy
(Lumens per Watt): 76

Output difference between CCTs - 5%, CRIs - 15%.

Description: 4" LED Module
25° Beam, 0° Tilt,
90 CRI, 3000K

Model: E4 LED
Input Power (Watts): 32.7
Input Power Factor: 0.98
Absolute Luminous
Flux (Lumens): 2456
Lumen Efficacy
(Lumens per Watt): 75

Description: 4" LED Module
40° Beam, 0° Tilt,
90 CRI, 3000K

Model: E4 LED
Input Power (Watts): 32.8
Input Power Factor: 0.98
Absolute Luminous
Flux (Lumens): 2584
Lumen Efficacy
(Lumens per Watt): 79

ANGLE	0°	45°	90°
0°	8192	8192	8192
5°	7438	7514	7532
10°	5277	5300	5297
15°	3190	3214	3209
20°	1898	1908	1900
25°	1066	1077	1064
30°	610	626	608
35°	319	386	325
40°	161	249	162
45°	94	145	94
50°	62	77	63
55°	37	49	37
60°	25	30	25
65°	12	16	13
70°	1	7	2
75°	0	0	0
80°	0	0	0
85°	0	0	0
90°	0	0	0

ANGLE	0°	45°	90°
0°	6907	6907	6907
5°	6578	6568	6565
10°	5455	5476	5467
15°	3575	3584	3595
20°	1856	1910	1947
25°	997	1040	1057
30°	623	654	660
35°	330	433	358
40°	153	276	165
45°	88	149	96
50°	57	73	61
55°	32	44	35
60°	19	25	21
65°	8	12	9
70°	0	4	1
75°	0	0	0
80°	0	0	0
85°	0	0	0
90°	0	0	0

ANGLE	0°	45°	90°
0°	4517	4517	4517
5°	4385	4393	4402
10°	4053	4071	4076
15°	3498	3518	3534
20°	2595	2648	2698
25°	1635	1620	1598
30°	860	850	804
35°	374	429	396
40°	179	224	190
45°	101	123	107
50°	60	75	64
55°	31	47	32
60°	19	26	20
65°	7	12	8
70°	1	3	1
75°	0	0	0
80°	0	0	0
85°	0	0	0
90°	0	0	0

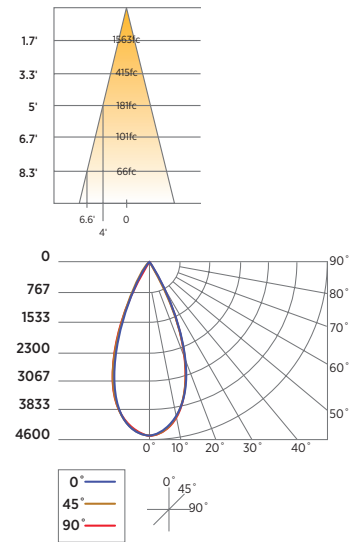
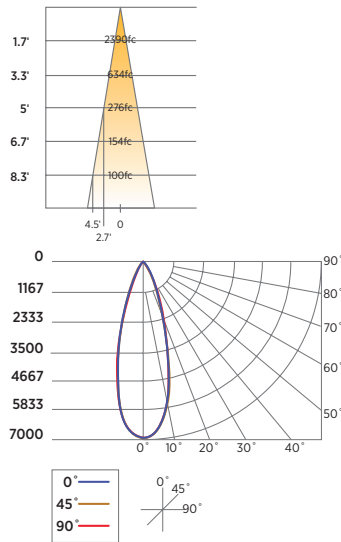
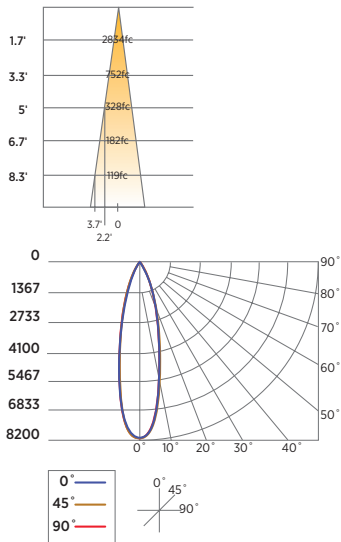

ELEMENT™ 4" LED

ADJUSTABLE DOWNLIGHT

PHOTOMETRICS

Description: 4" LED Module
60° Beam, 0° Tilt,
80 CRI, 3000K

Model: E4 LED

Input Power (Watts): 30.7

Input Power Factor: 0.98

Absolute Luminous
Flux (Lumens): 3178

Lumen Efficacy
(Lumens per Watt): 103.4

Output difference between CCTs - 5%, CRIs - 15%.

ANGLE	0°	45°	90°
0°	3209	3209	3209
5°	3215	3152	3158
10°	3103	3067	3068
15°	2869	2852	2881
20°	2428	2393	2468
25°	1881	1814	1930
30°	1398	1324	1441
35°	982	939	1038
40°	597	603	681
45°	334	359	393
50°	186	202	210
55°	89	118	98
60°	46	74	50
65°	25	38	27
70°	6	15	7
75°	4	4	4
80°	3	3	3
85°	1	1	1
90°	0	0	0

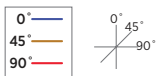
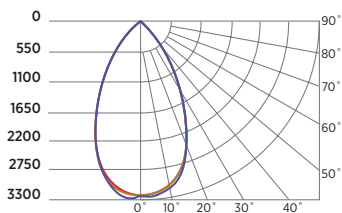
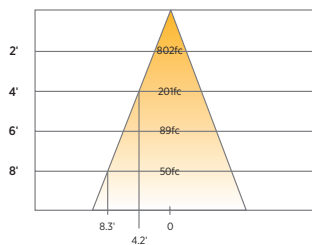

ELEMENT™ 4" LED

ADJUSTABLE DOWNLIGHT

PROJECT INFORMATION

JOB NAME AND INFORMATION

FIXTURE TYPE AND QUANTITY

NOTES
