

ELEMENT™ MULTIPLES

1X1, 1X2, 1X3, 1X4, AND 2X2 OPEN APERTURE

Element Multiples feature a patented LED Spot Dome module that allows tool-free adjustment and locking while maintaining center beam through the aperture at all tilt and rotation angles. The open design also supports general illumination and wall wash modules creating a clean, refined look below the ceiling. Flangeless housings include extruded, precision-welded aluminum plaster plates, while flanged housings feature a color-matched, cold-rolled steel ceiling flange. Available in 1x1, 1x2, 1x3, 1x4, and 2x2 configurations.

- Patented LED spot dome module enables remarkable tool-free adjustment and locking
- 1-step for static white; 2-step for 2200K and 2400K
- General Illumination and wall wash light module options
- Low profile design for use in standard 2x6 construction
- Includes integrated junction box approved for branch circuit through wiring
- Housing includes individual driver for each module (i.e. 2 drivers in a 1x2)
- Solite Soft Focus lens option



1X1 IN FLANGELESS WHITE



1X2 IN FLANGELESS BLACK



1X3 IN FLANGELESS BLACK



1X4 IN FLANGELESS BLACK



2X2 IN FLANGELESS BLACK

SPECIFICATIONS

	ADJUSTABLE SPOT		GENERAL ILLUMINATION		WALL WASH	
	HIGH OUTPUT	LOW OUTPUT	HIGH OUTPUT	LOW OUTPUT	HIGH OUTPUT	LOW OUTPUT
DELIVERED LUMENS PER MODULE	40° - 1370	40° - 1050	1100	1015	1610	989
WATTS PER MODULE	18.7	12.4	21		18.6	
EFFICACY	74	74	52		86	
CRI	80+ or 90+					
CBCP	20° - 4973 30° - 3296 40° - 3396 60° - 1700		NA		NA	
CCT	2200K, 2400K, 2700K, 3000K, or 3500K					
COLOR CONSISTENCY	1-step (2-step for 2200K, 2400K)					
VOLTAGE	120V or 277V					
DIMMING¹	Standard reverse-phase, forward-phase, and TRIAC dimming down to <1% 0-10V down to 5%					
POWER SUPPLY	Constant current driver with +.9 power factor and +80% efficiency					
OPTICS	Adjustable spot		Lambertian		Asymmetric	
ADJUSTABILITY	35° tilt and 360° rotation with tool-free locking		NA		NA	
CEILING APPEARANCE	Flanged or flangeless					
CEILING THICKNESS	Up to 2"					
CEILING APERTURE	5" x 5" ceiling cut-out per module					
HOUSING	IC Airtight (low output only), Non-IC Airtight, Chicago Plenum. IC suitable for insulation rating up to R60					
SIZE	1x1, 1x2, 1x3, 1x4, or 2x2					
CONSTRUCTION	Heavy-gauge, cold-rolled steel					
FINISH	Black or White powder coat (White is paintable)					
GENERAL LISTINGS	ETL Listed, Damp Location.					
CALIFORNIA TITLE 24	Registered CEC Appliance Database. Complies with CEC 2019 Title 24 Part 6 (JA8-2016, JA8-2019) (for 90 CRI versions).					
L70	50,000 hours min					
WARRANTY²	5 years					

LUMEN/CBCP MULTIPLIERS

CCT	80 CRI MULTIPLIER	90 CRI MULTIPLIER
2200K	—	0.51
2400K	—	0.71
2700K	0.95	0.80
3000K	1.00	0.85
3500K	1.05	0.90

Lumen output will vary by CCT and CRI. See photometric charts for output information.

Data in chart reflect 3000K/80 CRI values unless noted.

Custom output/custom RAL/custom CCT available, contact Quotes Department. Light modules and housings sold separately.

Ordering grids available on page 2.

¹See visualcomfort.com for dimmer compatibility.

²Visit visualcomfort.com for specific warranty limitations and details.

ELEMENT™ MULTIPLES

1X1, 1X2, 1X3, 1X4, AND 2X2 OPEN APERTURE

ORDERING GRIDS

HOUSING

PRODUCT	SIZE ¹	CEILING APPEARANCE	OUTPUT	HOUSING TYPE	VOLTAGE	DIMMING/DRIVER	FINISH
EMOH ELEMENT MULTIPLES OPEN APERTURE	11 1X1	L FLANGELESS	LH HIGH OUTPUT	I IC AIRTIGHT ²	120 120V	ELV LOW-VOLTAGE ELECTRONIC ³	B BLACK
	12 1X2	F FLANGED	LO LOW OUTPUT	N NON-IC AIRTIGHT	277 277V	O10 0-10V	W WHITE
	13 1X3			C CHICAGO PLENUM			
	14 1X4						
	22 2X2						

EMOH

For dimming details, refer to dimmer compatibility chart.

¹Light modules are required and must be ordered separately. Order 1 for 1x1, order 2 for 1x2, order 3 for 1x3, and order 4 for 1x4 or 2x2.

²Low-output only.

³Universal dimming is reverse-phase, forward-phase, TRIAC and 0-10V. 277V is only compatible with 0-10V dimming.

LIGHT MODULES

PRODUCT	CRI/CCT	OUTPUT	FINISH
EMO ELEMENT MULTIPLES OPEN APERTURE	827 80 CRI, 2700K, 1-STEP	A20 ADJUSTABLE, 20° OPTIC	B BLACK
	830 80 CRI, 3000K, 1-STEP	A30 ADJUSTABLE, 30° OPTIC	W WHITE
	835 80 CRI, 3500K, 1-STEP	A40 ADJUSTABLE, 40° OPTIC	
	922 90 CRI, 2200K, 2-STEP	A60 ADJUSTABLE, 60° OPTIC	
	924 90 CRI, 2400K, 2-STEP	WW WALL WASH	
	927 90 CRI, 2700K, 1-STEP	GI GENERAL ILLUMINATION	
	930 90 CRI, 3000K, 1-STEP		
	935 90 CRI, 3500K, 1-STEP		

EMO

Light modules are required and must be ordered separately. Order 1 for 1x1, order 2 for 1x2, order 3 for 1x3, and order 4 for 1x4 or 2x2.

REPLACEMENT OPTICS

PRODUCT	BEAM SPREAD
353LEDGATOPT	20 20°
	30 30°
	40 40°
	60 60°

LENSES/LOUVERS¹

PRODUCT	TYPE	FINISH
MOC	GG PLAIN GLASS	-B BLACK
	SF SOLITE SOFT FOCUS	-W WHITE
	SB SANDBLASTED	
	LL LINEAR SPREAD	
	EC EGGCRATE LOUVER	
	LS1 1" LONG SNOOT	
	LS12 1/2" LONG SNOOT	

353LEDGATOPT

MOC

¹ Lenses/louvers mounted to lamp assembly only (maximum of 2 optical components).



ELEMENT™ MULTIPLES

1X1, 1X2, 1X3, 1X4, AND 2X2 OPEN APERTURE

TRIMS

FLANGED

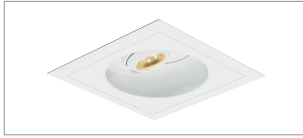

ADJUSTABLE SPOT

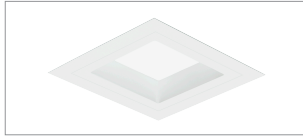

GENERAL ILLUMINATION

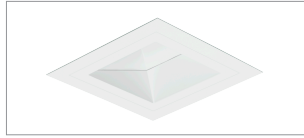

WALL WASH

FINISH



BLACK



WHITE
(PAINTABLE)

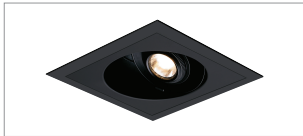

ADJUSTABLE SPOT



GENERAL ILLUMINATION

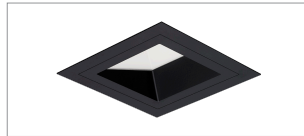

WALL WASH

FLANGELESS



ADJUSTABLE SPOT

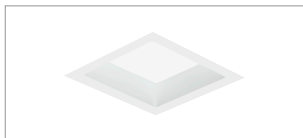

GENERAL ILLUMINATION

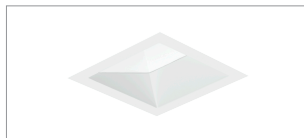

WALL WASH



ADJUSTABLE SPOT

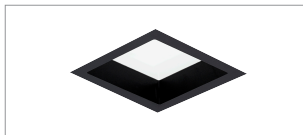

GENERAL ILLUMINATION

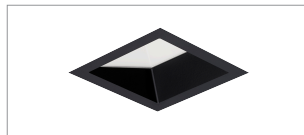

WALL WASH

LIGHT MODULES

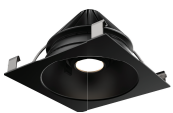

ADJUSTABLE SPOT



GENERAL ILLUMINATION



WALL WASH

ELEMENT™ MULTIPLES

1X1, 1X2, 1X3, 1X4, AND 2X2 OPEN APERTURE

CEILING APPEARANCE

Multiples are available in both black and white (field-paintable) finishes.

1X1

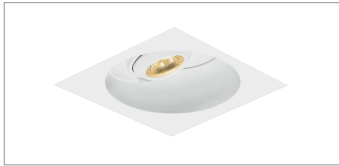

ADJUSTABLE SPOT

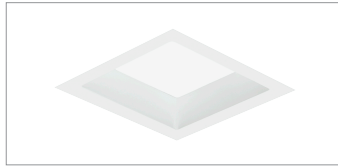

GENERAL ILLUMINATION

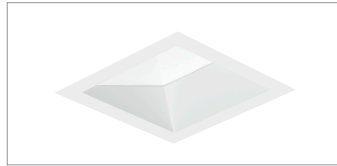

WALL WASH

1X2



ADJUSTABLE SPOT

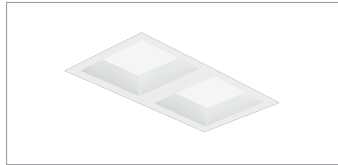

GENERAL ILLUMINATION

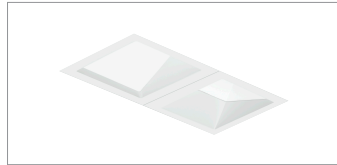

WALL WASH

1X3



ADJUSTABLE SPOT



ADJUSTABLE SPOT AND
GENERAL ILLUMINATION



ADJUSTABLE SPOT AND WALL WASH

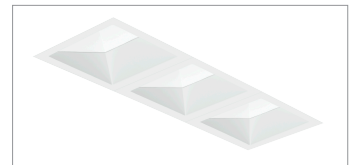

WALL WASH

1X4



ADJUSTABLE SPOT

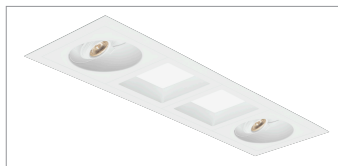

ADJUSTABLE SPOT AND
GENERAL ILLUMINATION



ADJUSTABLE SPOT AND WALL WASH

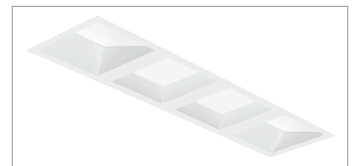

GENERAL ILLUMINATION AND
WALL WASH

2X2



ADJUSTABLE SPOT

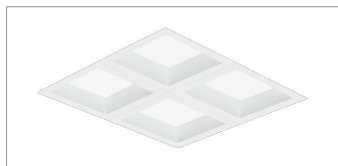

GENERAL ILLUMINATION



ADJUSTABLE SPOT, GENERAL
ILLUMINATION AND WALL WASH

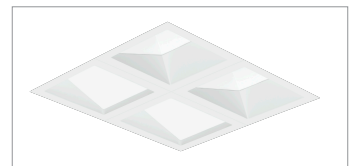

WALL WASH



ELEMENT™ MULTIPLES

1X1, 1X2, 1X3, 1X4, AND 2X2 OPEN APERTURE

DIMENSIONS

FLANGED

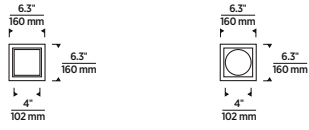

1X1 SQUARE OR ROUND

FLANGELESS



1X1 SQUARE OR ROUND

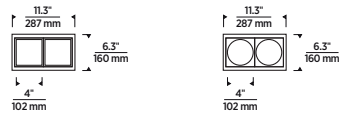

1X2 SQUARE OR ROUND

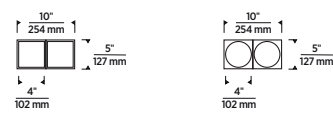

1X2 SQUARE OR ROUND

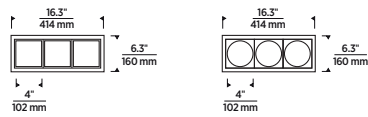

1X3 SQUARE OR ROUND

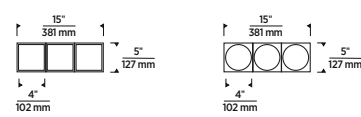

1X3 SQUARE OR ROUND

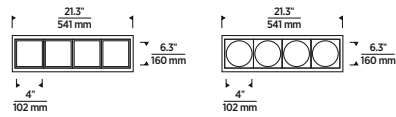

1X4 SQUARE OR ROUND

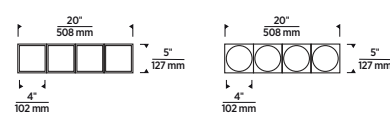

1X4 SQUARE OR ROUND

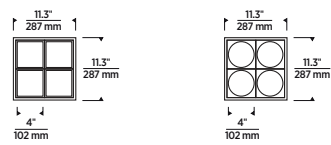

2X2 SQUARE OR ROUND

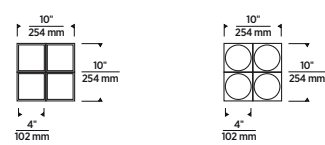

2X2 SQUARE OR ROUND

ELEMENT™ MULTIPLES

1X1, 1X2, 1X3, 1X4, AND 2X2 OPEN APERTURE

HOUSING

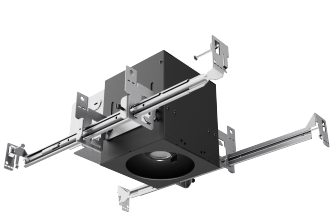

1X1

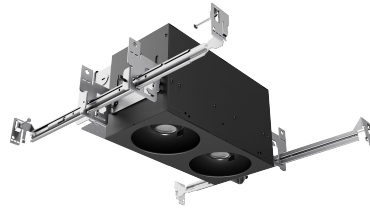

1X2

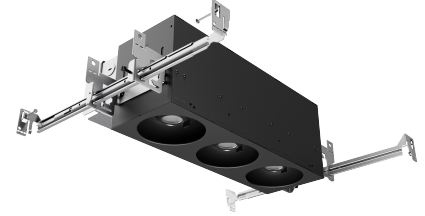

1X3

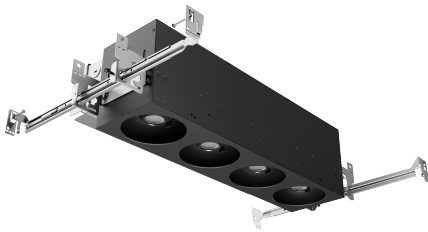

1X4

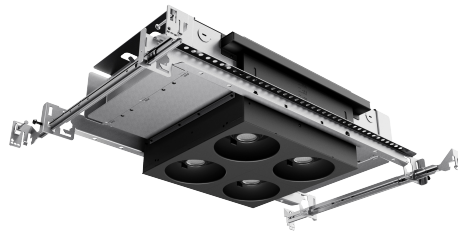

2X2

HOUSING DIMENSIONS

SIZE	OVERALL LENGTH	OVERALL WIDTH	HOUSING HEIGHT
1x1	9.9" 251 mm	IC Airtight/ Non-IC Airtight: 8.7" 221 mm	5.8" 147 mm
1x2	14.9" 378 mm		
1x3	19.9" 505 mm	or	
1x4	24.9" 632 mm	Chicago Plenum: 7.5" 191 mm	
2x2	24.4" 620 mm	11.3" 287 mm	

Maximum ceiling thickness is 2".

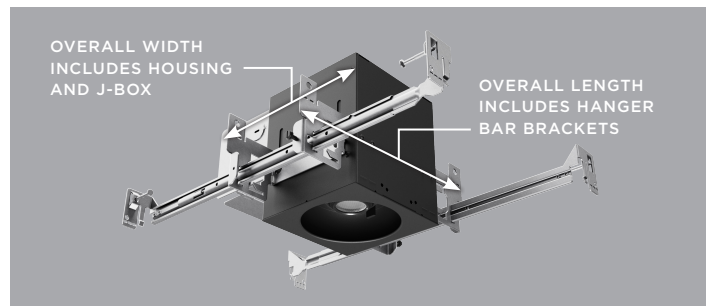

ELEMENT™ MULTIPLES

1X1, 1X2, 1X3, 1X4, AND 2X2 OPEN APERTURE

PHOTOMETRICS

Description: LED Multiples
20° Beam, 0° Tilt,
80 CRI, 3000K

Model: Low Output

Input Power (Watts): 12.4

Input Power Factor: 0.98

Absolute Luminous
Flux (Lumens): 984

Lumen Efficacy
(Lumens per Watt): 79

Output difference between CCTs - 5%, CRIs - 15%.

Description: LED Multiples
30° Beam, 0° Tilt,
80 CRI, 3000K

Model: Low Output

Input Power (Watts): 12.4

Input Power Factor: 0.98

Absolute Luminous
Flux (Lumens): 860

Lumen Efficacy
(Lumens per Watt): 69

Description: LED Multiples
40° Beam, 0° Tilt,
80 CRI, 3000K

Model: Low Output

Input Power (Watts): 12.4

Input Power Factor: 0.98

Absolute Luminous
Flux (Lumens): 860

Lumen Efficacy
(Lumens per Watt): 69

ANGLE	0°	45°	90°
0°	3210	3210	3210
5°	2929	2897	2822
10°	2118	2098	2046
15°	1383	1383	1331
20°	864	857	833
25°	498	498	479
30°	270	276	263
35°	151	154	147
40°	82	85	80
45°	44	45	44
50°	26	25	26
55°	15	15	15
60°	9	9	9
65°	6	6	6
70°	2	2	2
75°	0	0	0
80°	0	0	0
85°	0	0	0
90°	0	0	0

ANGLE	0°	45°	90°
0°	2156	2156	2156
5°	2087	2073	2030
10°	1775	1751	1670
15°	1295	1266	1177
20°	832	807	731
25°	486	472	421
30°	266	260	233
35°	144	142	130
40°	80	80	78
45°	49	50	49
50°	33	33	34
55°	22	23	24
60°	14	15	16
65°	9	9	9
70°	6	6	5
75°	2	2	1
80°	0	0	0
85°	0	0	0
90°	0	0	0

ANGLE	0°	45°	90°
0°	2188	2188	2188
5°	2137	2136	2106
10°	1956	1938	1893
15°	1633	1608	1536
20°	1206	1175	1082
25°	736	705	632
30°	377	362	318
35°	179	174	151
40°	82	81	74
45°	42	42	39
50°	24	23	22
55°	14	13	12
60°	8	8	8
65°	5	5	5
70°	2	2	2
75°	1	0	0
80°	0	0	0
85°	0	0	0
90°	0	0	0

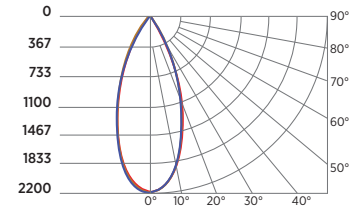
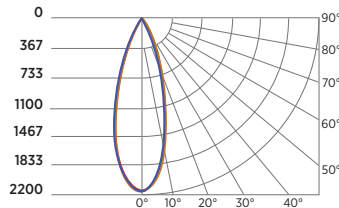
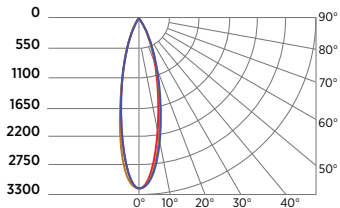
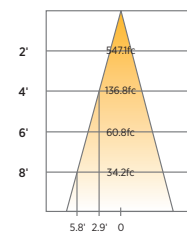
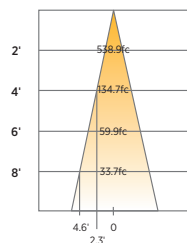
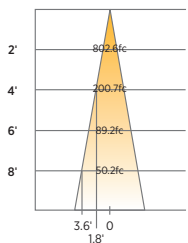

ELEMENT™ MULTIPLES

1X1, 1X2, 1X3, 1X4, AND 2X2 OPEN APERTURE

PHOTOMETRICS

Description: LED Multiples
20° Beam, 0° Tilt,
80 CRI, 3000K

Model: High Output

Input Power (Watts): 18.7

Input Power Factor: 0.98

Absolute Luminous Flux (Lumens): 1271

Lumen Efficacy (Lumens per Watt): 68

Description: LED Multiples
30° Beam, 0° Tilt,
80 CRI, 3000K

Model: High Output

Input Power (Watts): 18.7

Input Power Factor: 0.98

Absolute Luminous Flux (Lumens): 1114

Lumen Efficacy (Lumens per Watt): 60

Description: LED Multiples
40° Beam, 0° Tilt,
80 CRI, 3000K

Model: High Output

Input Power (Watts): 18.7

Input Power Factor: 0.98

Absolute Luminous Flux (Lumens): 1371

Lumen Efficacy (Lumens per Watt): 73

Output difference between CCTs - 5%, CRIs - 15%.

ANGLE	0°	45°	90°
0°	4179	4179	4179
5°	3539	3591	3744
10°	2488	2547	2772
15°	1614	1651	1773
20°	994	1017	1091
25°	550	570	619
30°	296	307	336
35°	163	171	184
40°	91	95	103
45°	51	52	58
50°	29	30	33
55°	17	18	19
60°	11	11	12
65°	5	6	7
70°	1	1	3
75°	0	0	0
80°	0	0	0
85°	0	0	0
90°	0	0	0

ANGLE	0°	45°	90°
0°	2770	2770	2770
5°	2582	2594	2624
10°	2101	2117	2177
15°	1458	1483	1539
20°	898	917	962
25°	509	519	549
30°	273	280	299
35°	148	153	165
40°	85	88	96
45°	53	56	61
50°	36	38	42
55°	25	26	30
60°	16	17	20
65°	9	10	11
70°	4	5	6
75°	0	0	1
80°	0	0	0
85°	0	0	0
90°	0	0	0

ANGLE	0°	45°	90°
0°	2854	2854	2854
5°	2743	2741	2757
10°	2445	2440	2478
15°	1962	1970	2006
20°	1344	1360	1414
25°	750	781	828
30°	368	385	414
35°	176	182	196
40°	88	90	94
45°	45	47	48
50°	25	25	27
55°	14	14	15
60°	8	8	9
65°	4	4	6
70°	1	1	2
75°	0	0	0
80°	0	0	0
85°	0	0	0
90°	0	0	0

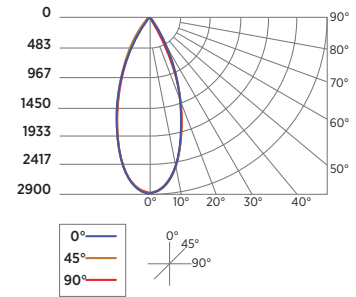
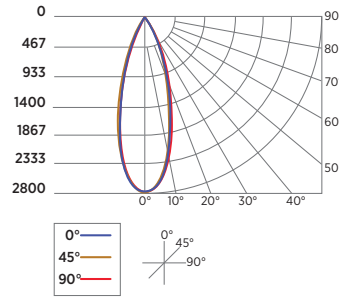
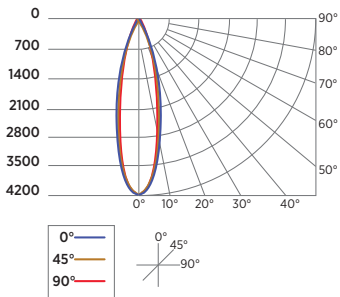
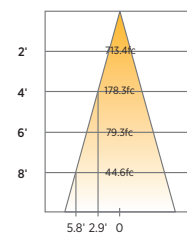
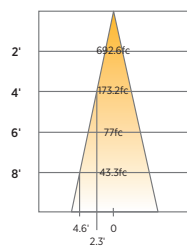
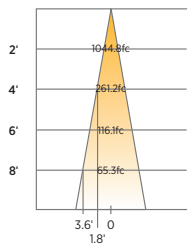

ELEMENT™ MULTIPLES

1X1, 1X2, 1X3, 1X4, AND 2X2 OPEN APERTURE

PHOTOMETRICS

Description: LED Multiples
60° Beam, 0° Tilt,
80 CRI, 3000K

Model: High Output

Input Power (Watts): 21.1

Input Power Factor: 0.98

Absolute Luminous
Flux (Lumens): 1412

Lumen Efficacy
(Lumens per Watt): 67

Output difference between CCTs - 5%, CRIs - 15%.

Description: LED Multiples
General Illumination,
80 CRI, 3000K

Model: GI High Output

Input Power (Watts): 20.9

Input Power Factor: 0.98

Absolute Luminous
Flux (Lumens): 1130

Lumen Efficacy
(Lumens per Watt): 54

Description: LED Multiples
Wall Wash,
80 CRI, 3000K

Model: Wall Wash High Output

Input Power (Watts): 18.5

Input Power Factor: 0.98

Absolute Luminous
Flux (Lumens): 1611

Lumen Efficacy
(Lumens per Watt): 87

ANGLE	0°	45°	90°
0°	1435	1435	1435
5°	1422	1414	1404
10°	1356	1340	1327
15°	1241	1231	1206
20°	1091	1088	1047
25°	913	897	862
30°	707	679	655
35°	503	486	465
40°	340	332	315
45°	225	213	201
50°	137	130	119
55°	80	76	66
60°	43	41	35
65°	22	21	17
70°	8	7	6
75°	1	0	0
80°	0	0	0
85°	0	0	0
90°	0	0	0

ANGLE	0°	45°	90°
0°	854	854	854
5°	843	847	846
10°	817	822	820
15°	772	780	772
20°	698	716	690
25°	591	624	587
30°	469	507	459
35°	360	390	352
40°	270	289	266
45°	202	209	198
50°	149	152	146
55°	110	108	107
60°	77	74	75
65°	49	46	57
70°	24	23	23
75°	5	7	4
80°	0	1	1
85°	0	0	0
90°	0	0	0

ANGLE	0°	45°	90°
0°	854	854	854
5°	843	847	846
10°	817	822	820
15°	772	780	772
20°	698	716	690
25°	591	624	578
30°	469	507	459
35°	360	390	352
40°	270	289	266
45°	202	209	198
50°	149	152	146
55°	110	108	107
60°	77	74	75
65°	49	46	47
70°	24	23	23
75°	5	7	4
80°	0	1	1
85°	0	0	0
90°	0	0	0

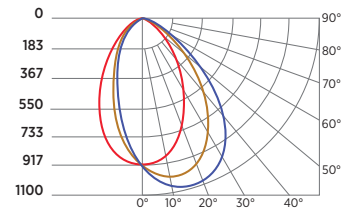
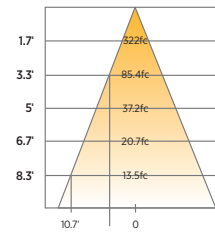
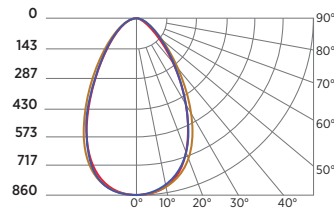
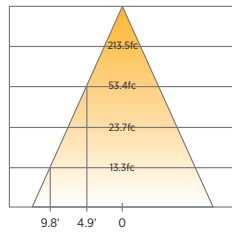
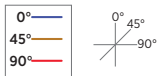
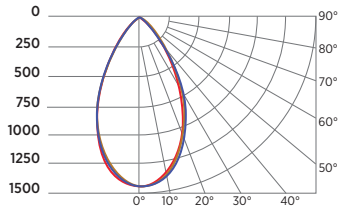
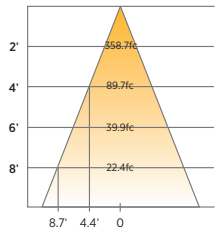

ELEMENT™ MULTIPLES

1X1, 1X2, 1X3, 1X4, AND 2X2 OPEN APERTURE

PROJECT INFORMATION

JOB NAME AND INFORMATION

FIXTURE TYPE AND QUANTITY

NOTES
