

ENTRA™ 3" CYLINDER

FIXED CYLINDER

The ENTRA 3" Fixed Cylinder provides a cost-effective option with a modern aesthetic for residential, hospitality, and commercial applications. ENTRA 3" Fixed Cylinders are a great solution for illumination in exposed ceiling applications. Mounting options include flush mount, surface mount, conduit mount, pendant mount, and cord mount with interchangeable optics. LED is recessed in the cylinder minimizing glare with warm dimming and static white options. Available in Black, Brushed Aluminum, and White (field paintable).



SHOWN IN WHITE

- Interchangeable optics: 18°, 25°, 40°, and 60°
- 1-step for static white 2700K, 3000K, and 3500K; and 2-step for all other configurations
- Several lens and louver options, including Solite Soft Focus

LUMEN/CBCP MULTIPLIERS

CCT	80 CRI MULTIPLIER	90 CRI MULTIPLIER
2200K	—	0.48
2400K	—	0.66
2700K	—	0.75
3000K	—	0.80
3500K	1.00	—

Lumen output will vary by CCT and CRI. See photometric charts for output information.

SPECIFICATIONS

WATTAGE	STATIC WHITE		WARM DIM	
	Lumens	Efficacy	Lumens	Efficacy
12W	1400	116	1000	75
15W	1800	120	1300	70
19W	2250	118	1600	68
27W	2900	107	2400	65
CRI	80+, 90+		90+	
CCT	2200K, 2400K, 2700K, 3000K, or 3500K		3000K-1800K	
CBCP	18° - 8,192 25° - 6,907 40° - 4,517 60° - 3,209			
COLOR CONSISTENCY	1-step (2-step for 2200K, 2400K)		2-step	
VOLTAGE	120V or 277V			
DIMMING¹	Standard reverse-phase, forward-phase, TRIAC, and 0-10V dimming down to 1% for 12W and 15W, and 5% for 19W and 27W eldoLED 0-10V or DALI-2 down to 0.1% Lutron Hi-lume EcoSystem down to 0.1%			
POWER SUPPLY	Constant current driver with +0.9 power factor and +80% efficiency			
BEAM SPREAD	Interchangeable optics: 18°, 25°, 40°, or 60°			
CEILING APPEARANCE	Flush Mount, Surface Mount (Canopy), Pendant Mount (Canopy), Conduit Mount (J-Box), or Cord Mount (Canopy)			
CONSTRUCTION	Cylinder: Aluminum			
FINISH	Reflector: White, Black, or Brushed Aluminum Cylinder: White, Black, or Brushed Aluminum			
GENERAL LISTINGS	ETL Listed. Damp Location.			
CALIFORNIA TITLE 24	Registered CEC appliance database. Complies with CEC 2019 Title 24 Part 6 (JA8-2016, JA8-2019) (for 90 CRI versions).			
L70	50,000 hours min			
WARRANTY²	5 years			

Data in chart reflects 3500K/80 CRI values, unless otherwise noted.

Ordering grids available on page 2.

¹See visualcomfort.com for dimmer compatibility.

²Visit visualcomfort.com for specific warranty limitations and details.

ENTRA™ 3" CYLINDER

FIXED CYLINDER

ORDERING GRIDS

CYLINDER

PRODUCT	MOUNTING	OUTPUT	CRI/CCT	BEAM SPREAD	FUNCTION	DRIVERS	REFLECTOR FINISH	CYLINDER FINISH
ENCY3R ENTRA CYLINDERS 3" ROUND	F FLUSH MOUNT 1	-L12 12W (1400 LMS)	835 80 CRI, 3500K, 1-STEP	1 18°	D DOWNLIGHT	INTEGRATED DRIVERS 120V/277V -UNV UNIVERSAL PHASE/0-10V 1%/5% ⁵	-B BLACK -W WHITE -A BRUSHED ALUMINUM	B BLACK W WHITE A BRUSHED ALUMINUM
	S SURFACE MOUNT (CANOPY)	-L15 15W (1800 LMS)	922 90 CRI, 2200K, 2-STEP	2 25°				
	C CONDUIT MOUNT (J-BOX) ²	-L19 19W (2250 LMS)	924 90 CRI, 2400K, 2-STEP	4 40°				
	P PENDANT MOUNT (CANOPY) ³	-L27 27W (2900 LMS)	927 90 CRI, 2700K, 1-STEP	6 60°				
	D CORD MOUNT (CANOPY) ⁴		930 90 CRI, 3000K, 1-STEP 9WD 90 CRI, WARM DIM, 3000K-1800K, 2-STEP					
ENCY3R	-				D	-		

For dimming details, refer to dimmer compatibility chart.

Standard cylinder reflectors do not accommodate any lens accessories. To use with lens accessories (max. 2), order the ENCY3LK Lens/Louver Kit.

¹F - Flush Mount includes adapter plate to assemble to standard 4" square or octagonal junction box prior to ceiling install.

²C - Conduit Mount includes custom junction box assembled at/below the ceiling.

³P - Pendant Mount for use with ECPS Cylinders pendant stems.

⁴D - Cord Mount includes 6 ft. of cord. Black cord used with Black and Brushed Aluminum Cylinders; White cord used with White Cylinders.

⁵UNV - Universal dimming is reverse-phase, forward-phase, TRIAC, and 0-10V. 277V is only compatible with 0-10V dimming. Dims down to 1% for 12W and 15W outputs, and 5% for 19W and 27W outputs.

⁶Remote drivers ship in 4" x 8" x 1.8" black enclosure for remote location mounting.

REPLACEMENT OPTICS

PRODUCT	BEAM SPREAD
353E4LEDCOPT	18 18°
	25 25°
	40 40°
	60 60°

353E4LEDCOPT

REFLECTOR OPTIC TOOL

PRODUCT ¹	
ENCY3TR	ENTRA CYLINDERS 3" REFLECTOR TOOL

ENCY3TR

¹It is highly recommended to order a reflector optic tool when purchasing lens/louvers kits as this will make removal of the existing reflector significantly easier.

LENS/LOUVER KIT

PRODUCT ¹	TYPE	REFLECTOR FINISH
ENCY3LK	SB SANDBLASTED LENS	-B BLACK
	SF SOLITE SOFT FOCUS LENS	-W WHITE
	LL LINEAR SPREAD LENS	-A BRUSHED ALUMINUM
	EC EGGCRATE LOUVER	

ENCY3LK

¹Required for use with lenses or louvers for Cylinders. Lens/louver kits include a reflector and 1 lens. To add additional lenses (max. 2), see accessories page. It is highly recommended to order a reflector optic tool when purchasing lens/louvers kits as this will make removal of the existing reflector significantly easier.

PENDANT STEMS

PRODUCT ¹	LENGTH ²	FINISH
ECPS	12 12"	B BLACK
	24 24"	W WHITE
	36 36"	A BRUSHED ALUMINUM
	48 48"	
	60 60"	
	72 72"	

ECPS

¹Required for Pendant Mount only.

²Consult Quotes Department for custom lengths to the inch.

VAULTED CEILING ADAPTER

PRODUCT	FINISH
ECVA PENDANT MOUNT ¹	B BLACK
ECVAD SURFACE MOUNT ²	W WHITE A BRUSHED ALUMINUM

¹For use with Pendant Mount. Adds 1.7" to the overall length of the stem. Accommodates slopes up to 45 degrees.

²For use with Surface Mount. Accommodates slopes up to 45 degrees.



ENTRA™ 3" CYLINDER

FIXED CYLINDER

CYLINDERS

FLUSH MOUNT



WHITE



BRUSHED ALUMINUM



BLACK

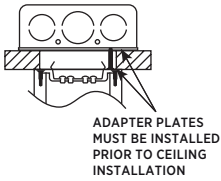
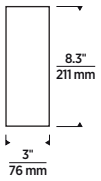

CONDUIT MOUNT (J-BOX)



WHITE



BRUSHED ALUMINUM



BLACK

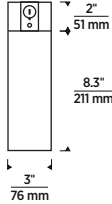

SURFACE MOUNT (CANOPY)



WHITE



BRUSHED ALUMINUM



BLACK

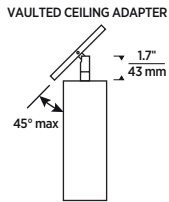
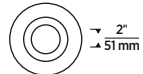
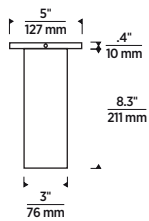

PENDANT MOUNT (CANOPY)



WHITE



BRUSHED ALUMINUM



BLACK

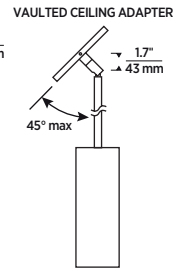
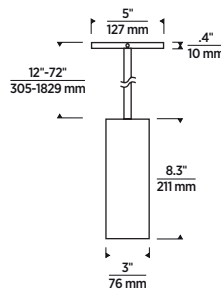

ENTRA™ 3" CYLINDER

FIXED CYLINDER

CYLINDERS, CONT.

CORD MOUNT (CANOPY)

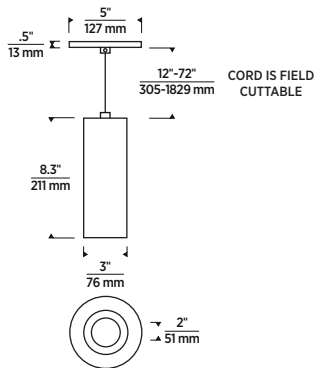

REMOTE DRIVER J-BOX

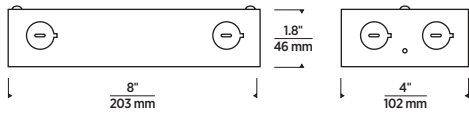

ENTRA™ 3" CYLINDER

FIXED CYLINDER

PHOTOMETRICS

Description: 3" Cylinder Fixed
18° Beam
90 CRI, 3000K

Input Power (Watts): 32.9
Input Power Factor: 0.99
Absolute Luminous Flux (Lumens): 2494
Lumen Efficacy (Lumens per Watt): 76

Output difference between CCTs - 5%, CRIs - 15%.

Description: 3" Cylinder Fixed
25° Beam
90 CRI, 3000K

Input Power (Watts): 32.7
Input Power Factor: 0.98
Absolute Luminous Flux (Lumens): 2456
Lumen Efficacy (Lumens per Watt): 75

Description: 3" Cylinder Fixed
40° Beam
90 CRI, 3000K

Input Power (Watts): 32.8
Input Power Factor: 0.98
Absolute Luminous Flux (Lumens): 2584
Lumen Efficacy (Lumens per Watt): 79

ANGLE	0°	45°	90°
0°	8192	8192	8192
5°	7438	7514	7532
10°	5277	5300	5297
15°	3190	3214	3209
20°	1898	1908	1900
25°	1066	1077	1064
30°	610	626	608
35°	319	386	325
40°	161	249	162
45°	94	145	94
50°	62	77	63
55°	37	49	37
60°	25	30	25
65°	12	16	13
70°	1	7	2
75°	0	0	0
80°	0	0	0
85°	0	0	0
90°	0	0	0

ANGLE	0°	45°	90°
0°	6907	6907	6907
5°	6578	6568	6565
10°	5455	5476	5467
15°	3575	3584	3595
20°	1856	1910	1947
25°	997	1040	1057
30°	623	654	660
35°	330	433	358
40°	153	276	165
45°	88	149	96
50°	57	73	61
55°	32	44	35
60°	19	25	21
65°	8	12	9
70°	0	4	1
75°	0	0	0
80°	0	0	0
85°	0	0	0
90°	0	0	0

ANGLE	0°	45°	90°
0°	4517	4517	4517
5°	4385	4393	4402
10°	4053	4071	4076
15°	3498	3518	3534
20°	2595	2648	2698
25°	1635	1620	1598
30°	860	850	804
35°	374	429	396
40°	179	224	190
45°	101	123	107
50°	60	75	64
55°	31	47	32
60°	19	26	20
65°	7	12	8
70°	1	3	1
75°	0	0	0
80°	0	0	0
85°	0	0	0
90°	0	0	0

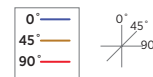
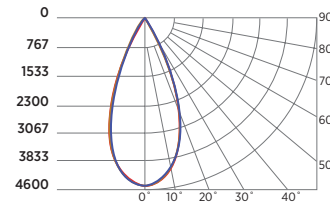
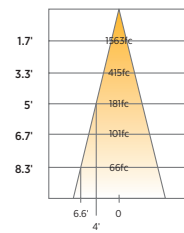
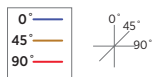
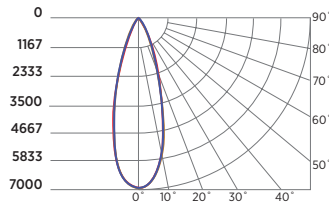
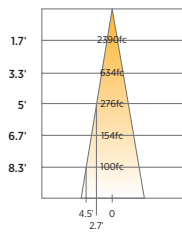
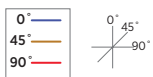
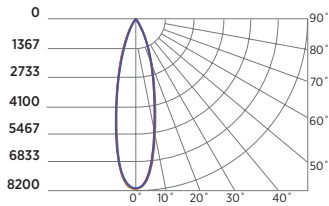
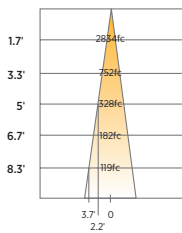

ENTRA™ 3" CYLINDER

FIXED CYLINDER

PHOTOMETRICS

Description: 3" Cylinder Fixed
60° Beam
90 CRI, 3000K

Input Power (Watts): 30.0

Input Power Factor: 0.98

Absolute Luminous Flux (Lumens): 2616

Lumen Efficacy (Lumens per Watt): 87

Output difference between CCTs - 5%, CRIs - 15%.

ANGLE	0°	45°	90°
0°	3092	3092	3092
5°	3042	3037	3025
10°	2858	2880	2860
15°	2583	2630	2606
20°	2221	2266	2196
25°	1693	1686	1603
30°	1188	1148	1114
35°	805	764	719
40°	495	463	423
45°	284	265	230
50°	152	142	125
55°	82	74	60
60°	42	38	34
65°	31	29	25
70°	24	22	18
75°	18	16	13
80°	12	11	9
85°	7	7	4
90°	5	4	3

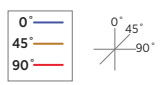
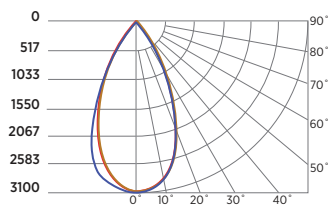
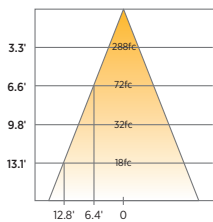

ENTRA™ 3" CYLINDER

FIXED CYLINDER

PROJECT INFORMATION

JOB NAME AND INFORMATION

FIXTURE TYPE AND QUANTITY

NOTES